

HP59301

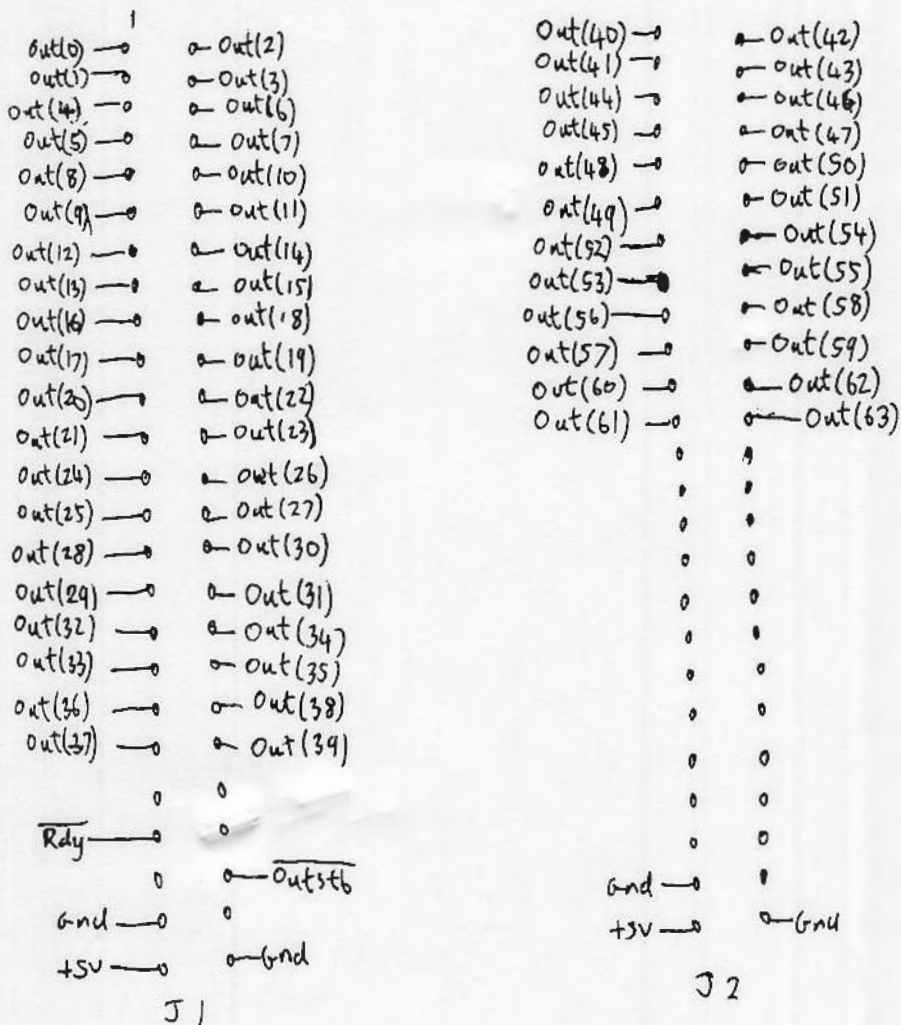

(Output Connectors)

Hp59301

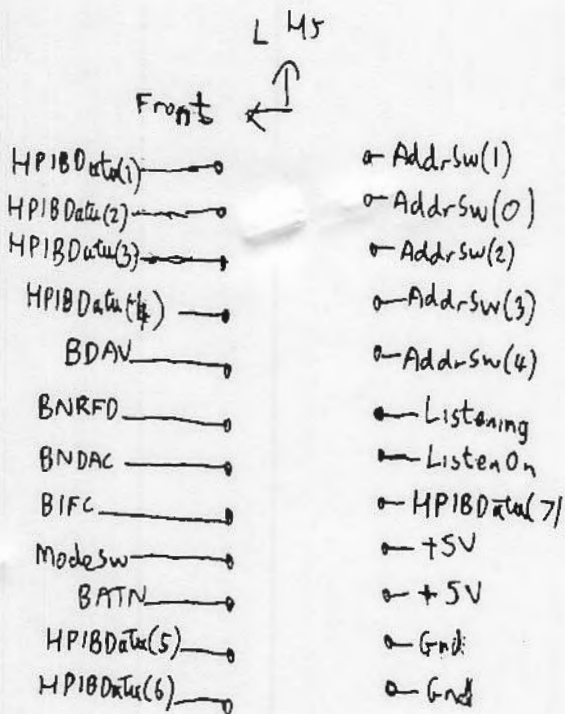
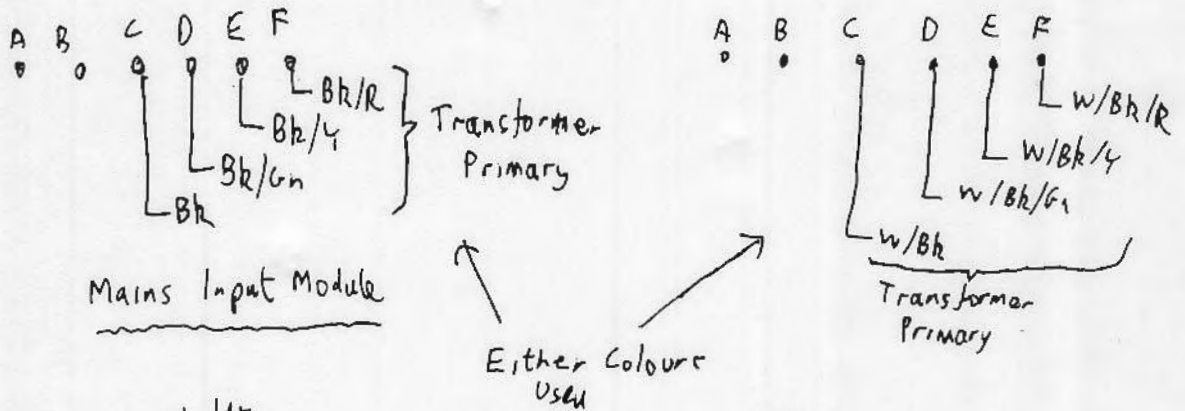

J3
(HPIB Connector PCB)

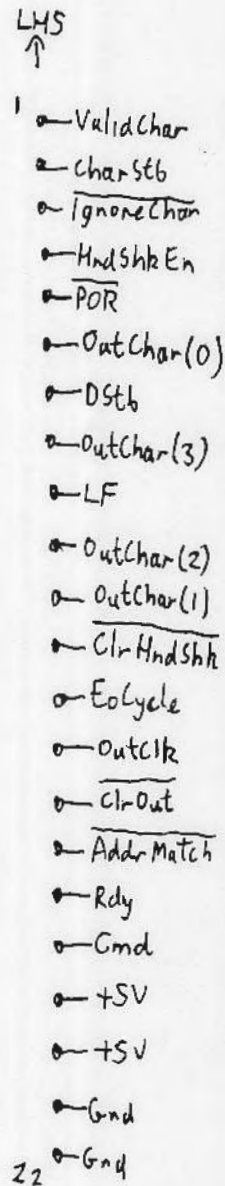

J4
(Test Connector)

HP59301

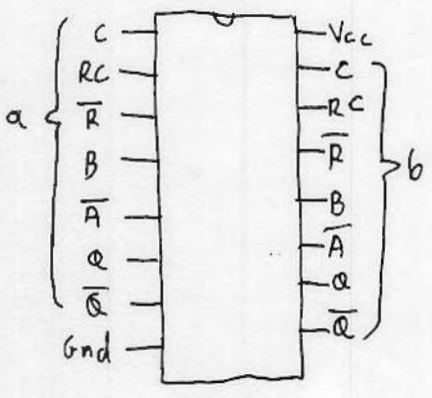

9602
Dual Retriggerable
Monostable

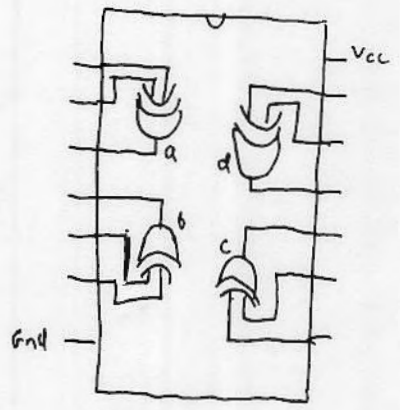

74L86
(Not as 7486)
Quad XOR gate

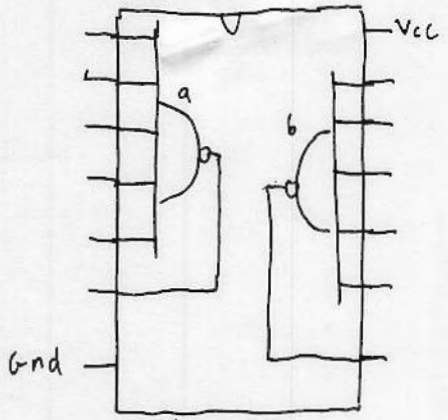

MC1800
Dual 5-input NAND
Gate (DTL)

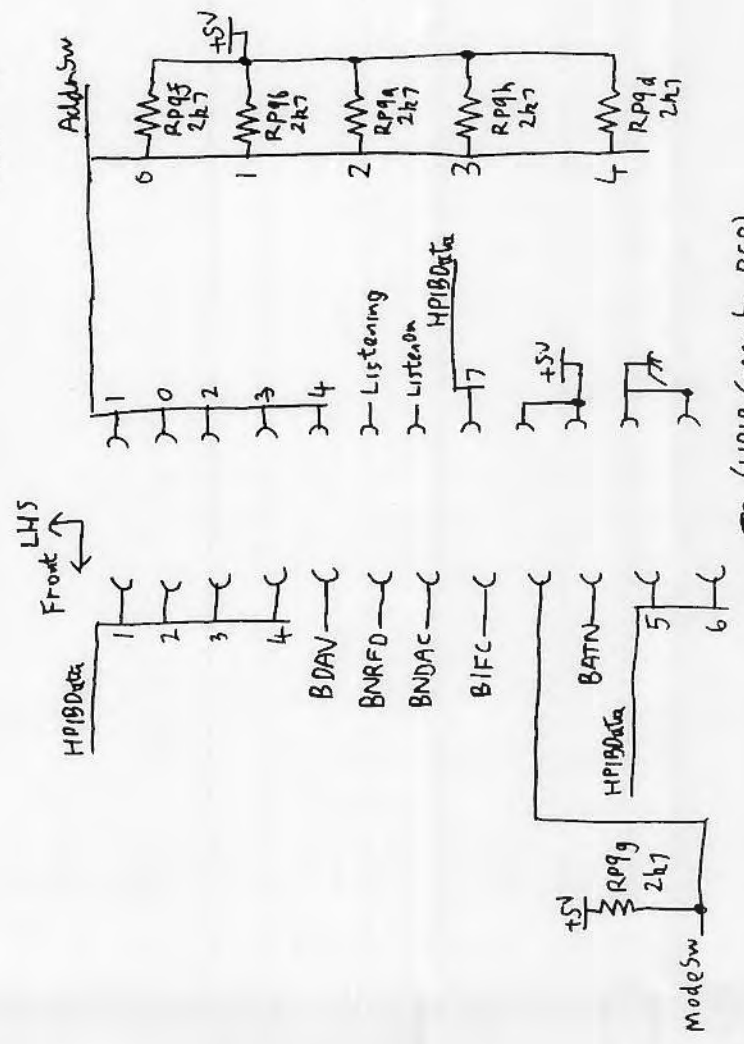
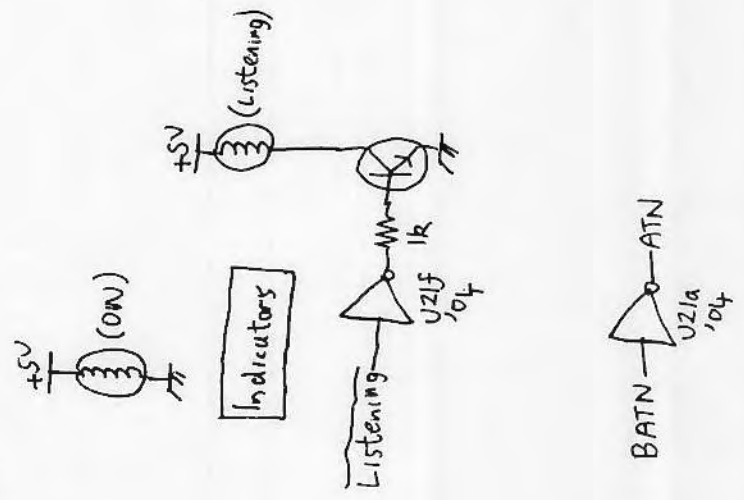
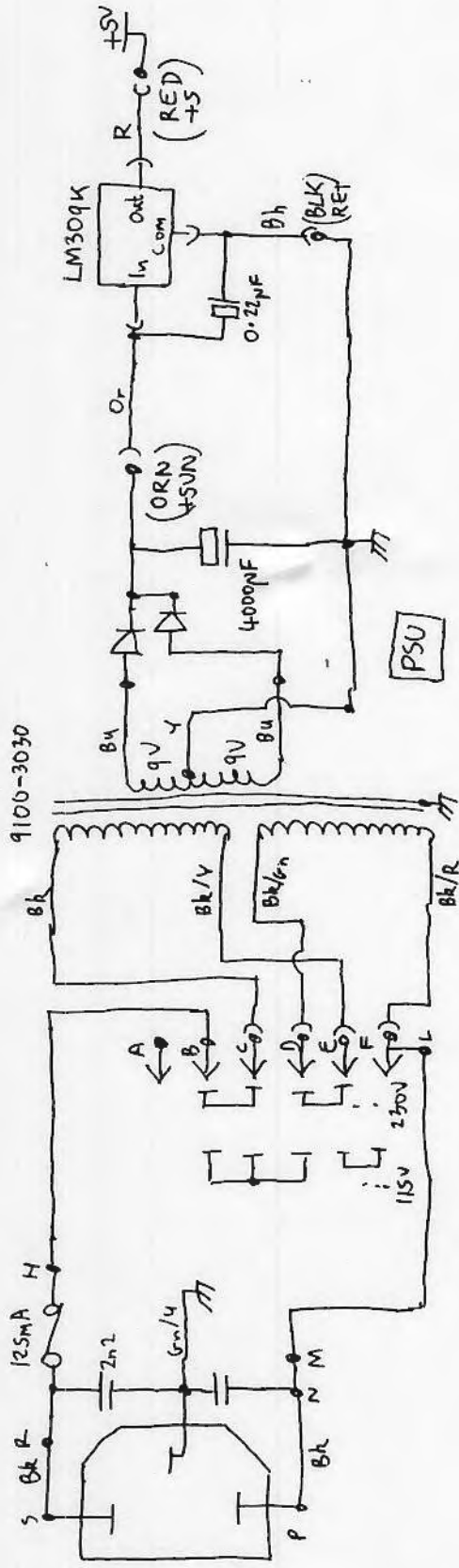

J3 (HPiB Connector PCB)

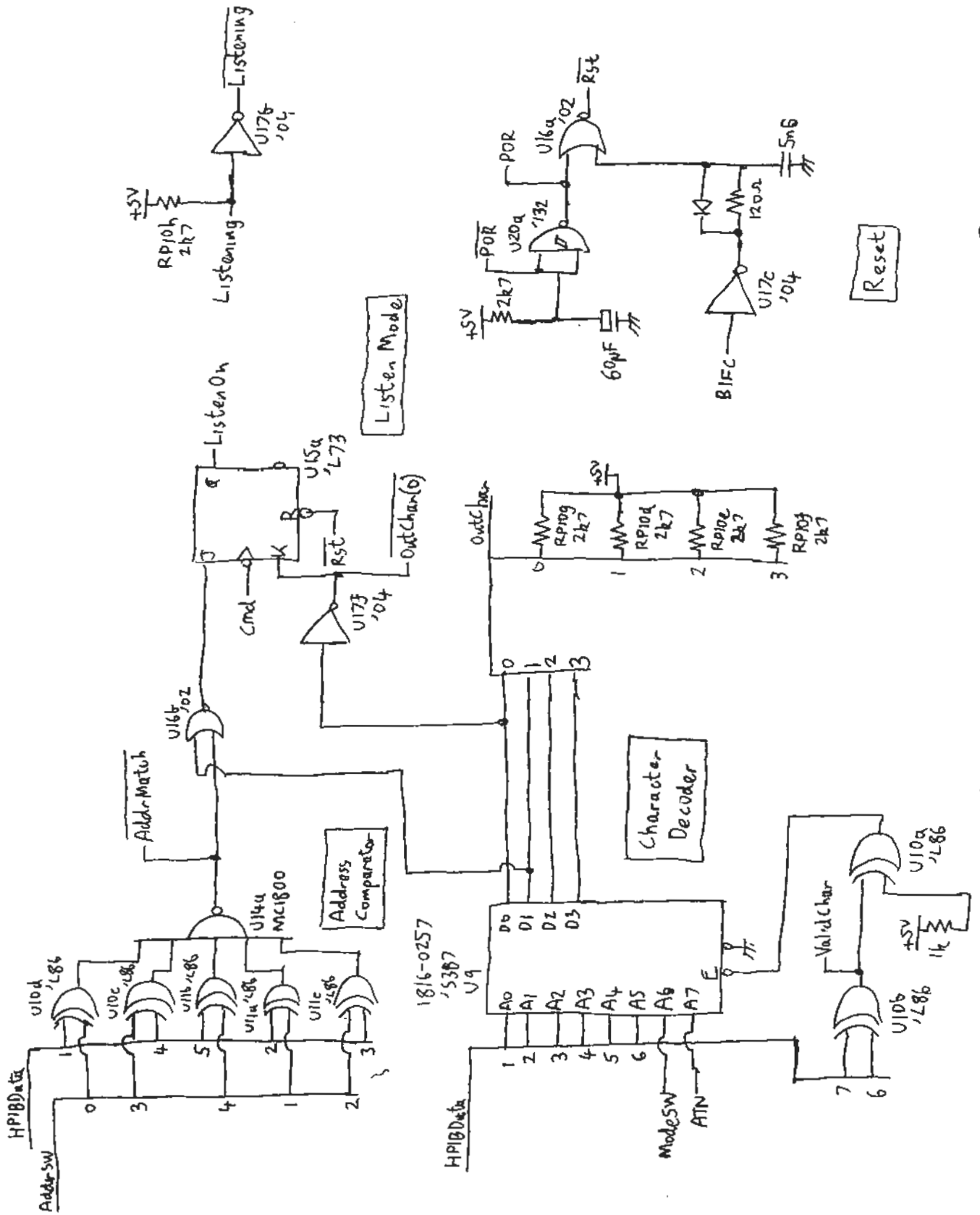

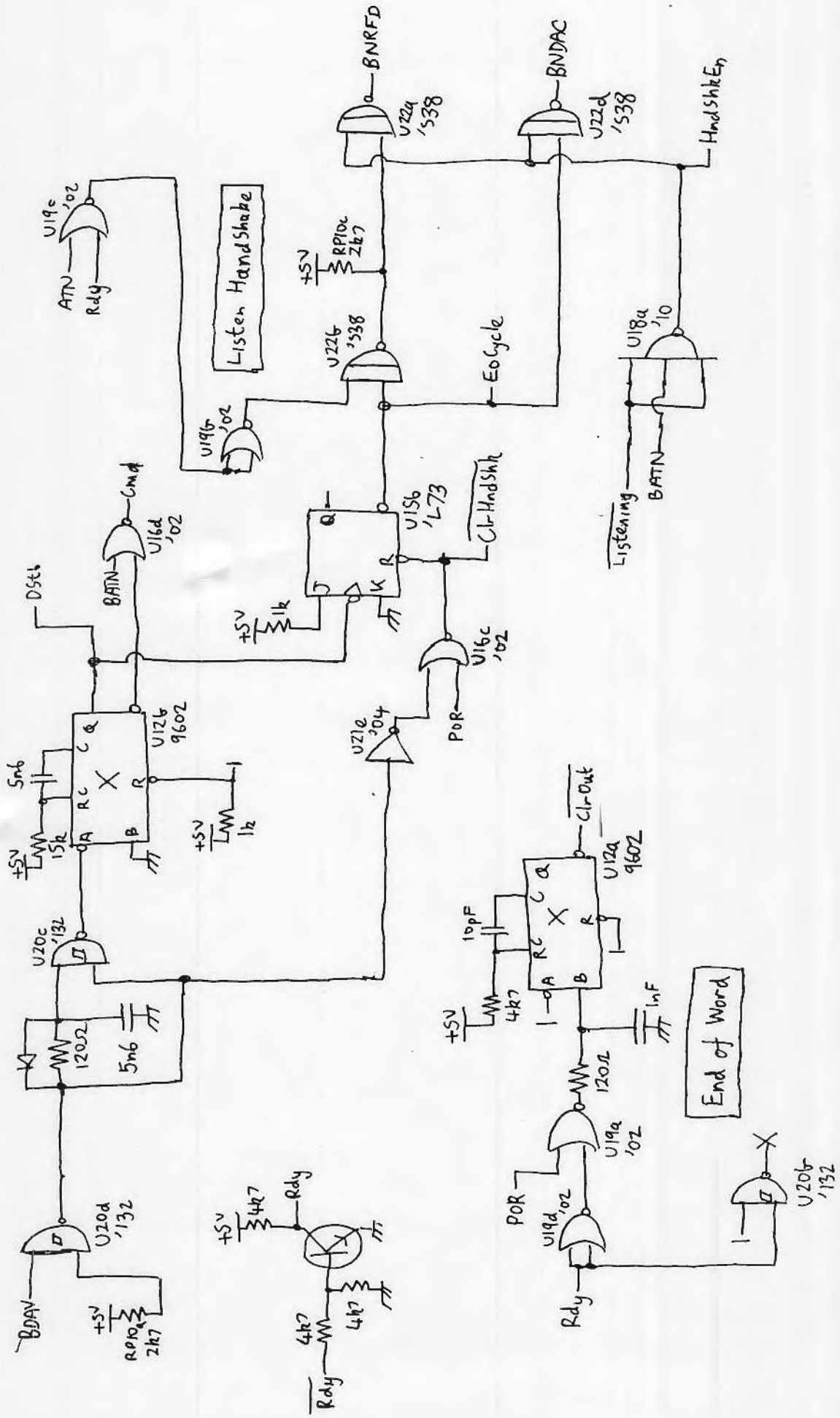

)

)

)

)

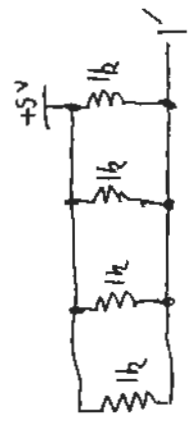
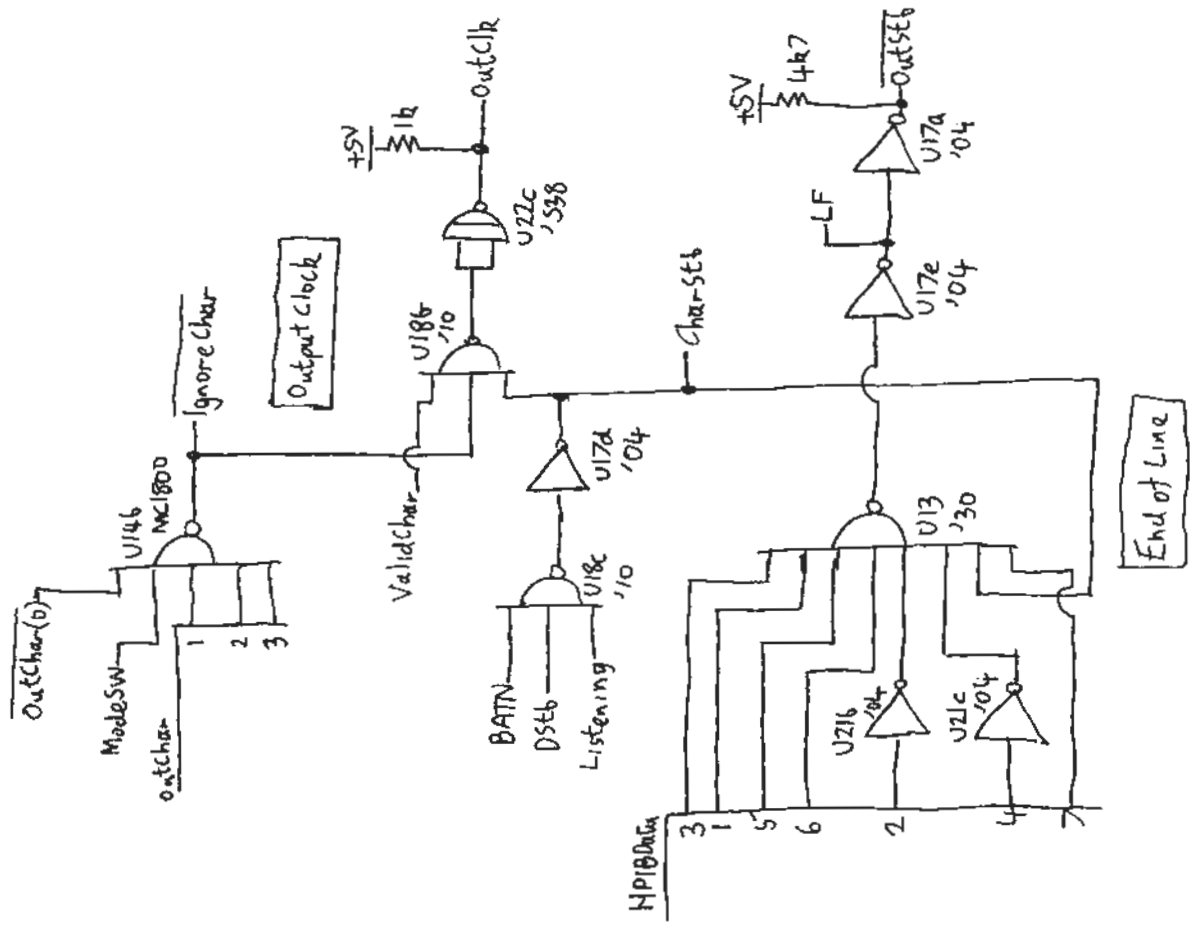
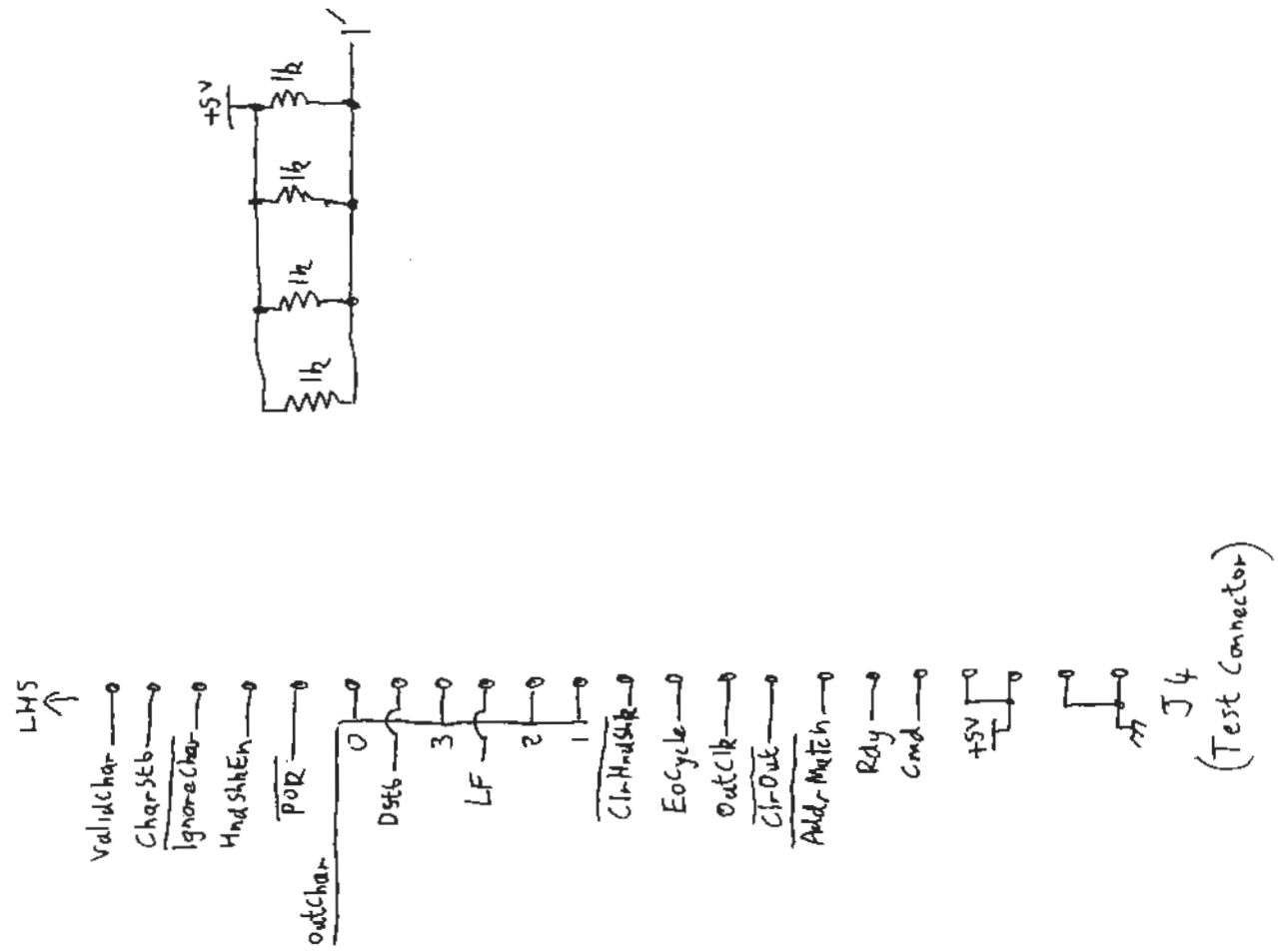

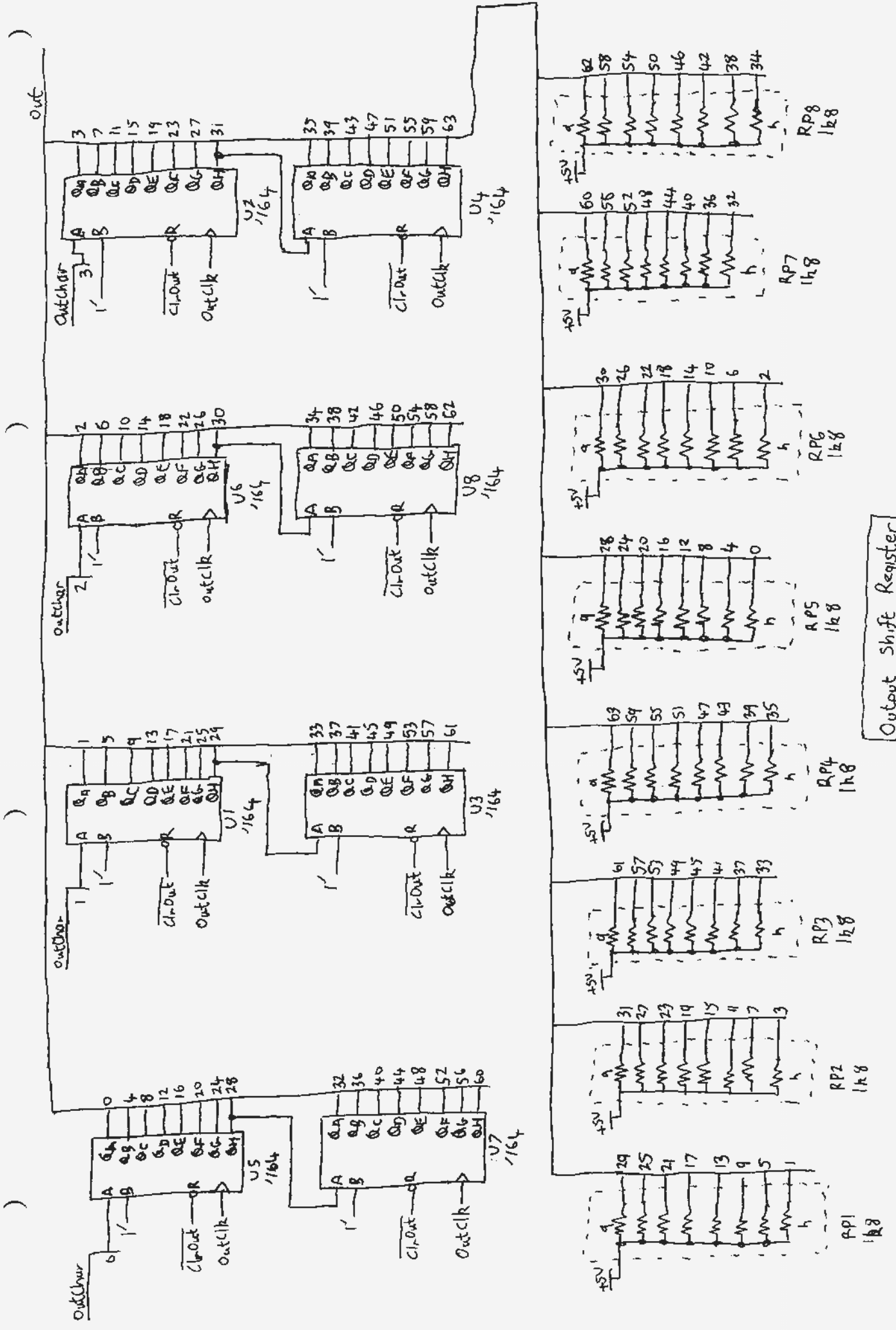

Output Shift Register

