

$$\begin{array}{c} \text{a} \\ \hline \text{s} | \text{g} | \text{b} \\ \hline \text{e} | \text{c} \\ \hline \text{d} \text{ o h} \end{array}$$

↓
Digit 1

1990-0495

(HP21 Display)

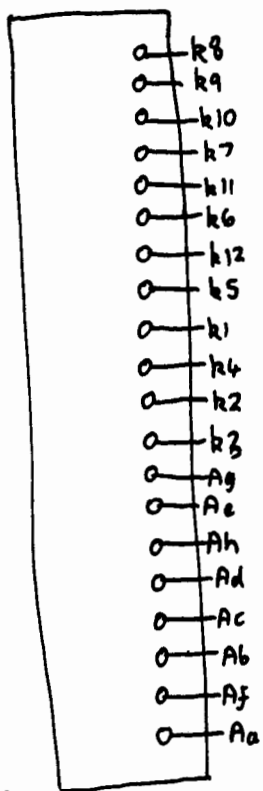
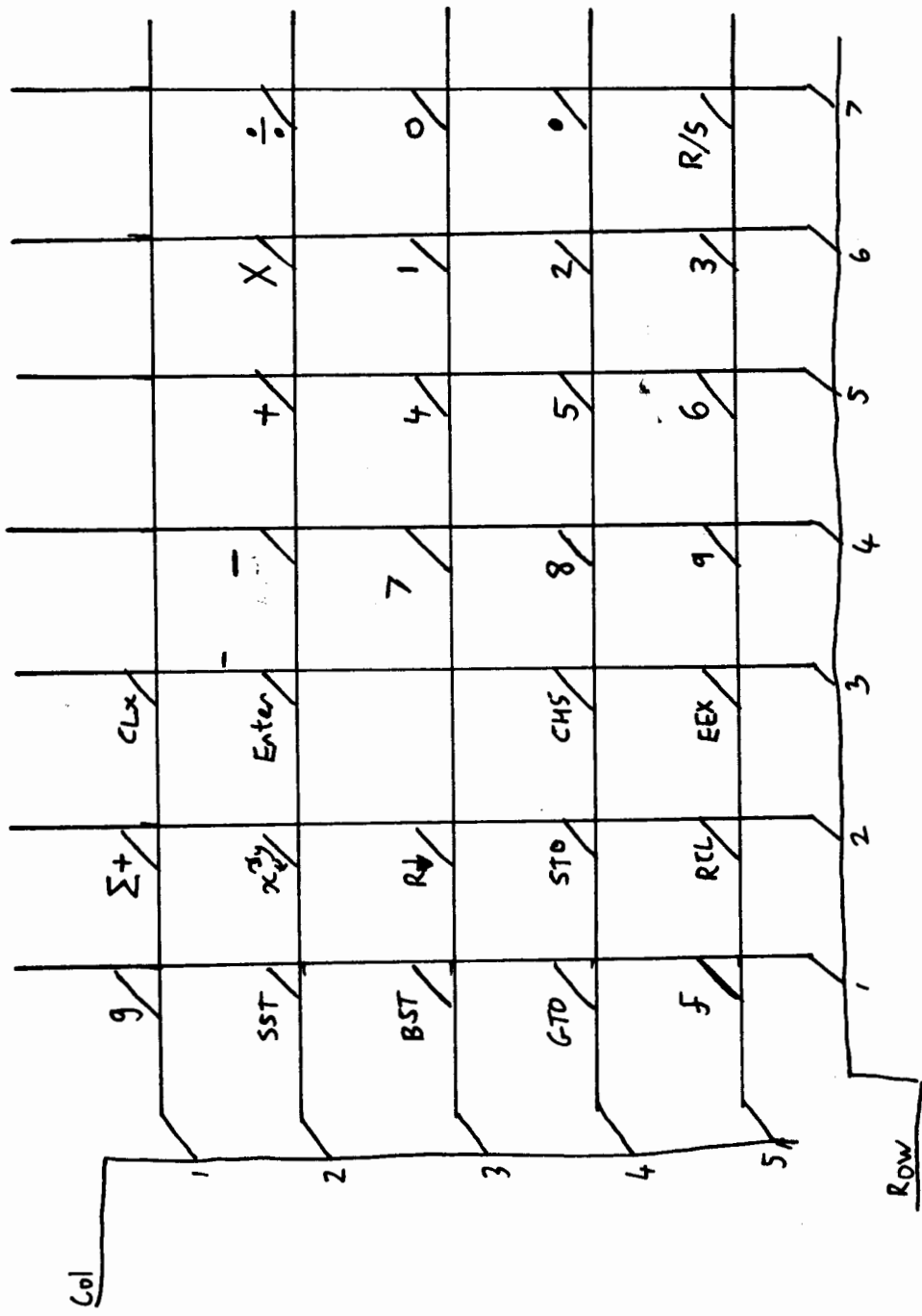
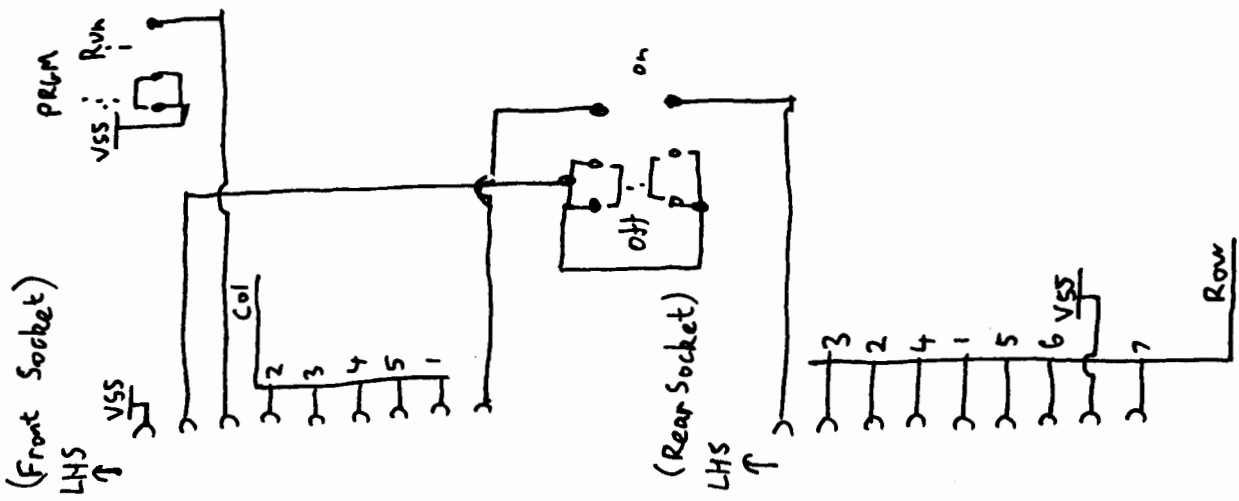

HP25 / HP25C Keyboard 00021-6000Z

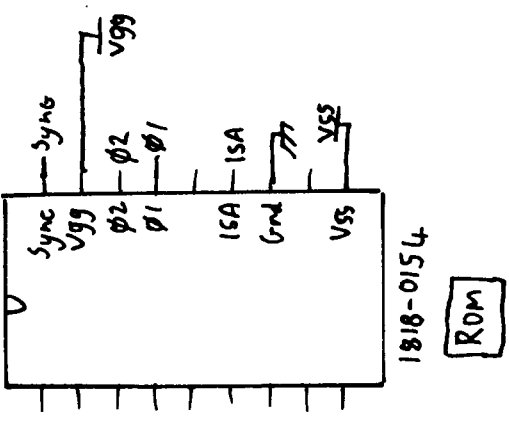
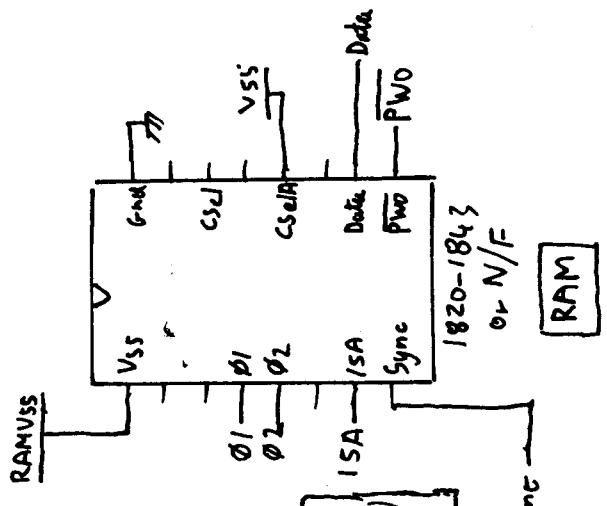
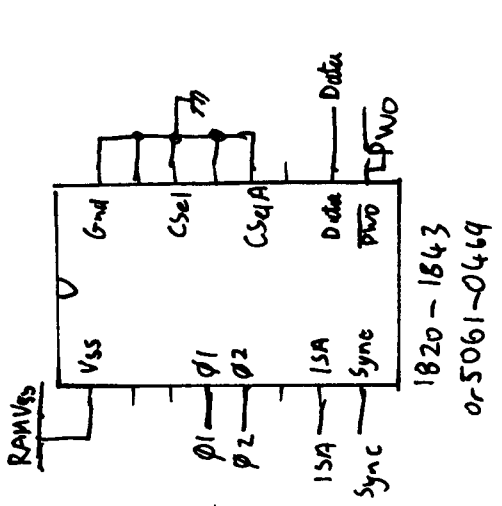

RAM: Either 2 off 1820-1843 (16 Register)
or 1 off 5061-0469 (32 Register).

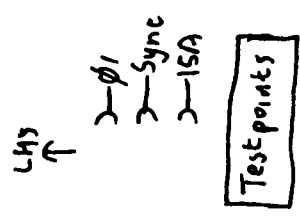
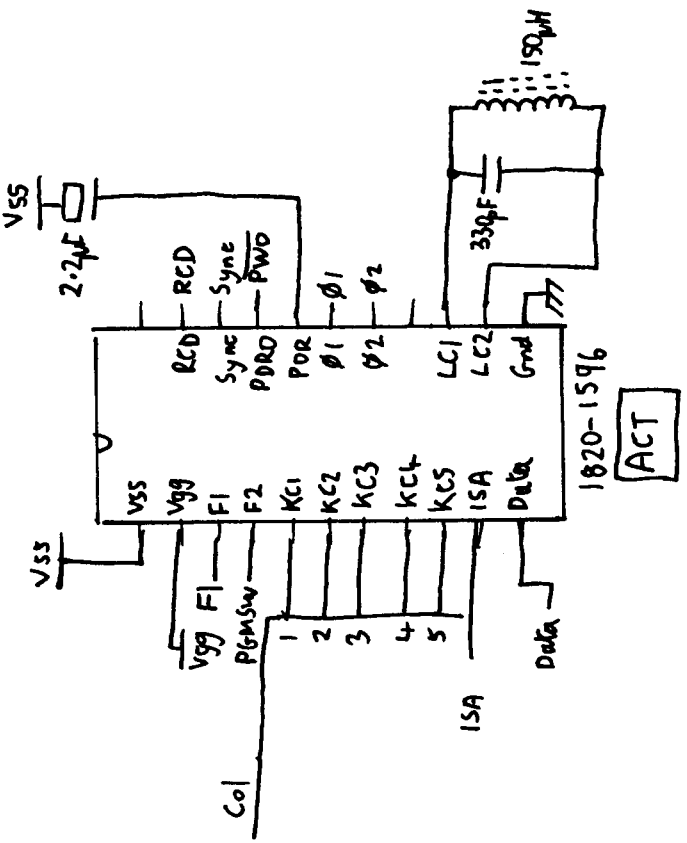

(Display Pins)
LHS
↑

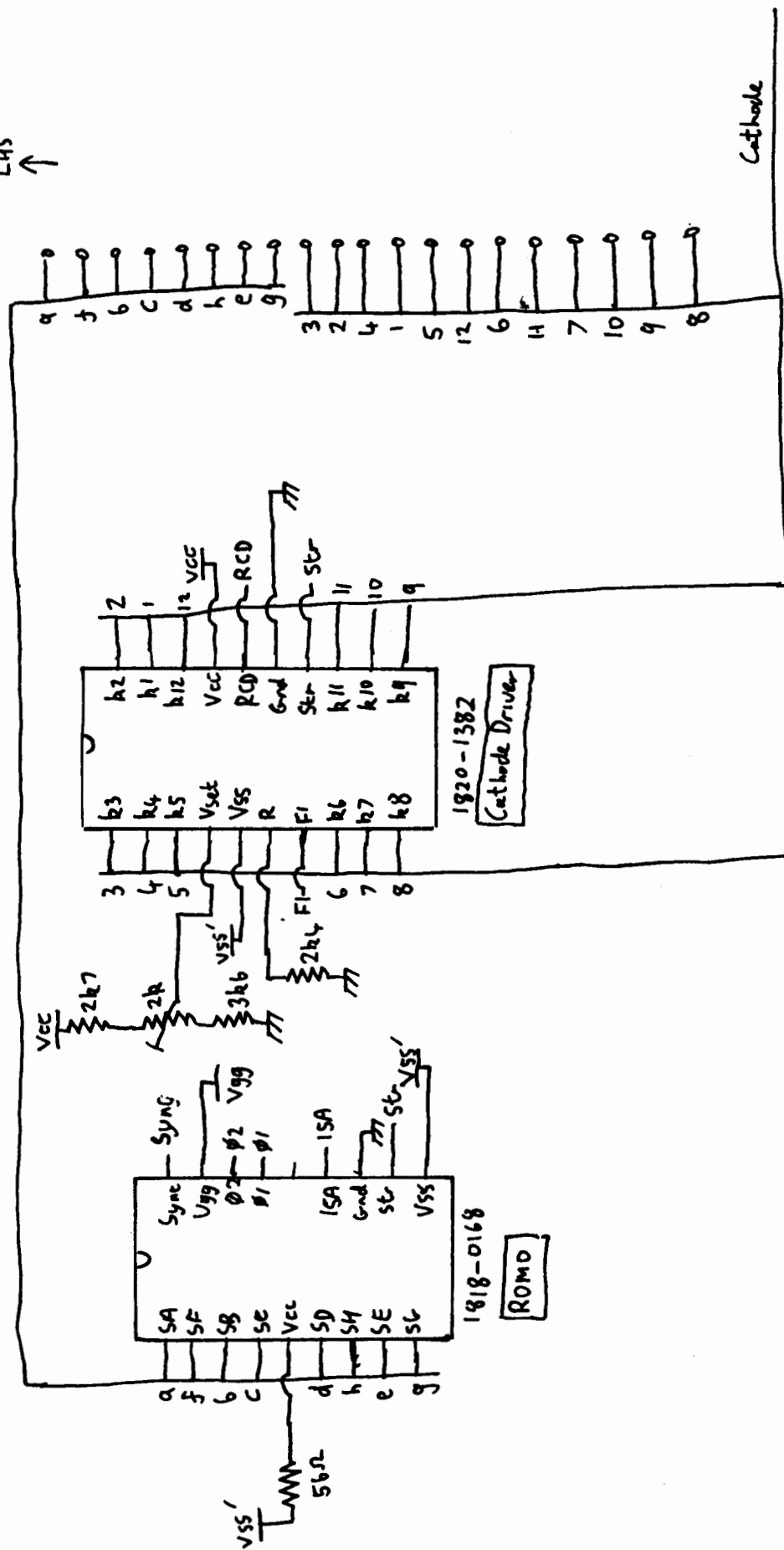

Cathode

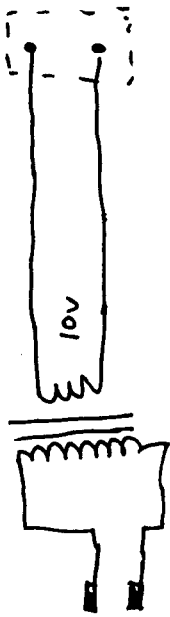

HP 9205A Woodstock Charger

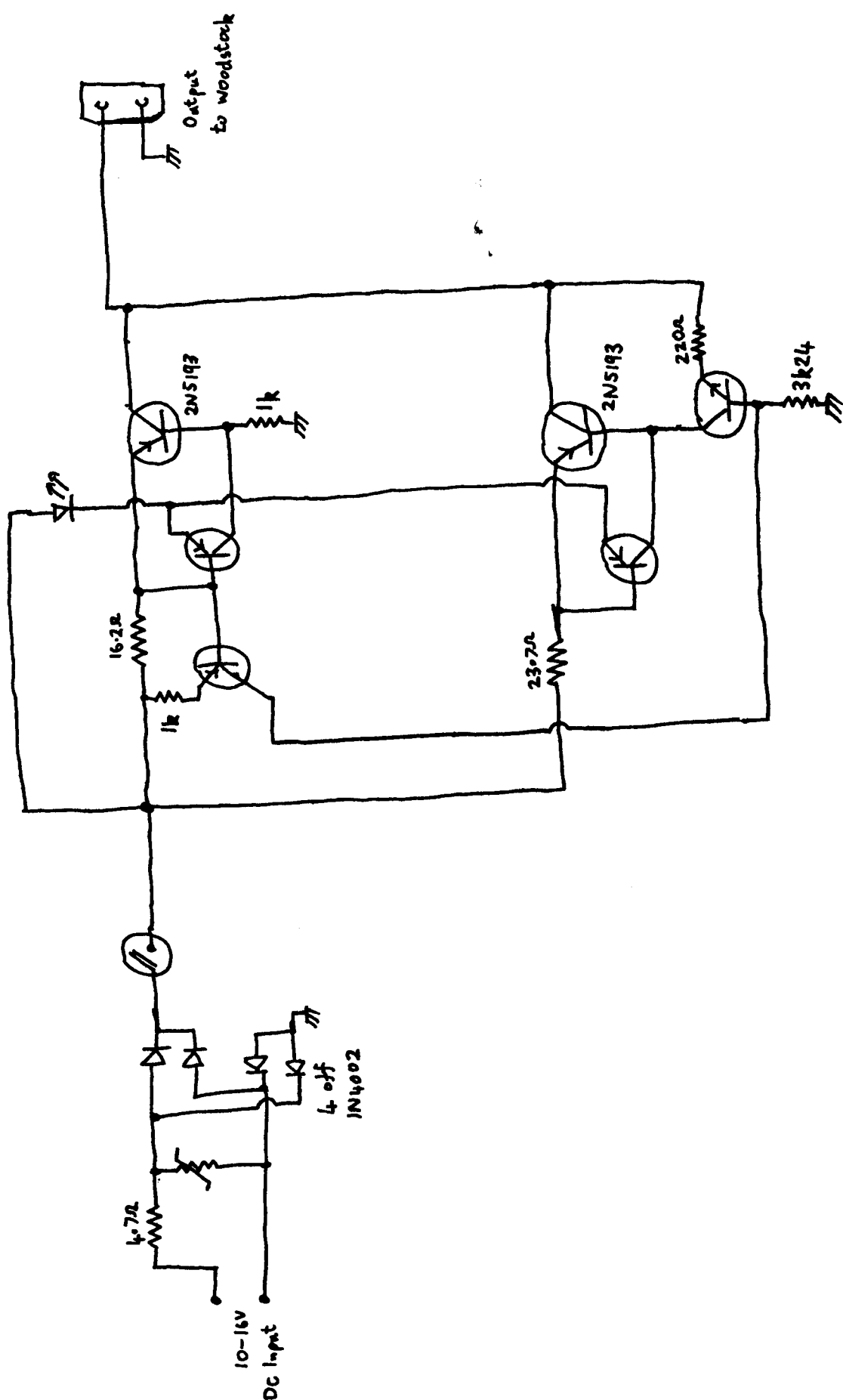

82055 DC Charger

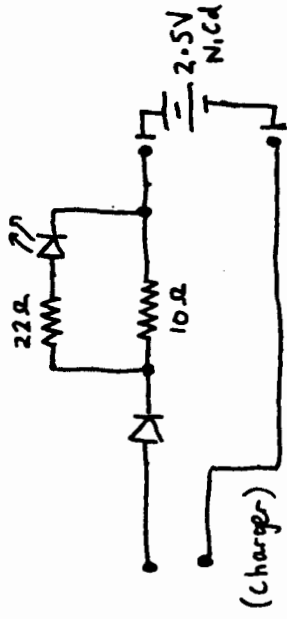

82028-60001

HP 82028 Woodstock Reserve Power Pack