

HP2748A

↑ RMS

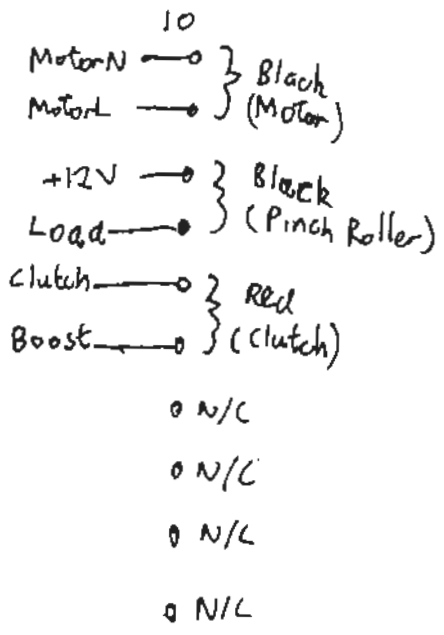

Barrier strip

Rear
 ↑ RMS

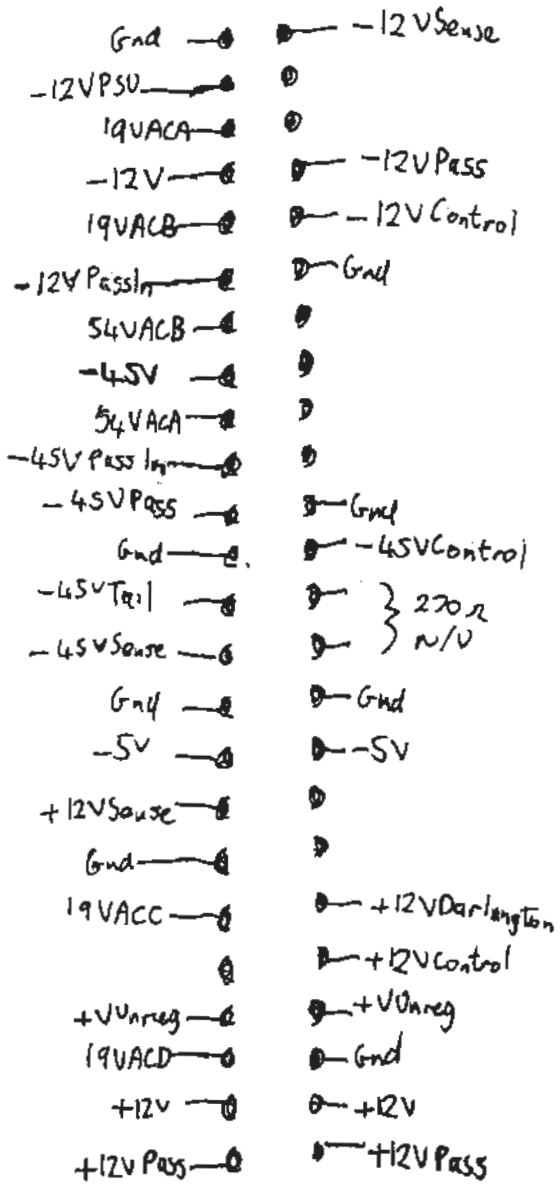

A1
 (PSU)

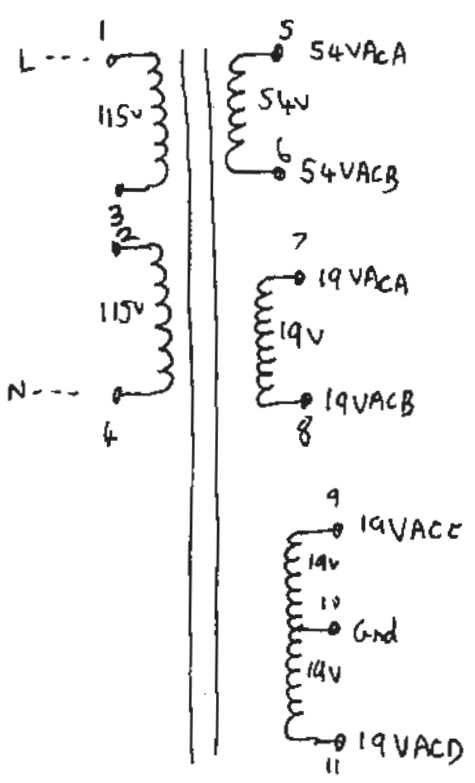

Mains Transformer

HP2748A

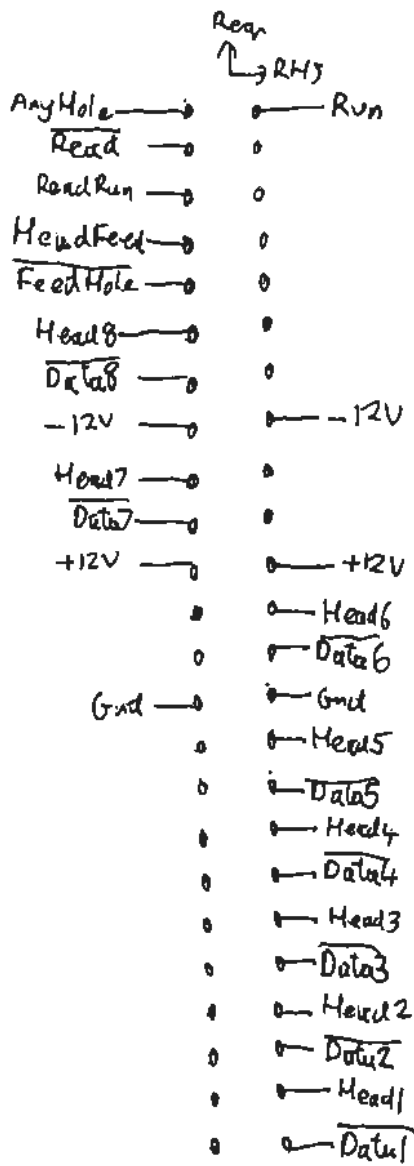
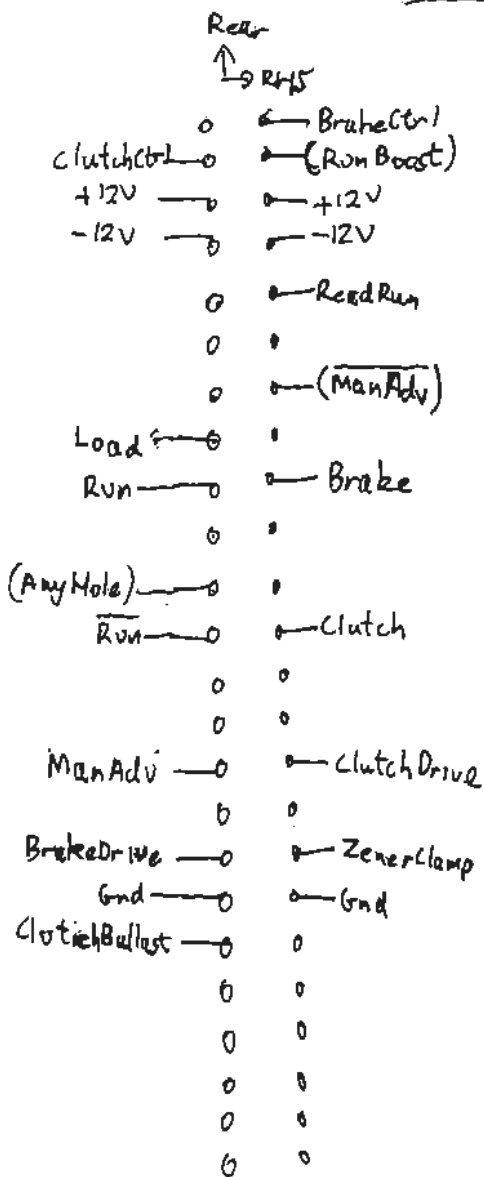

A2
(control)

A3
(Data)

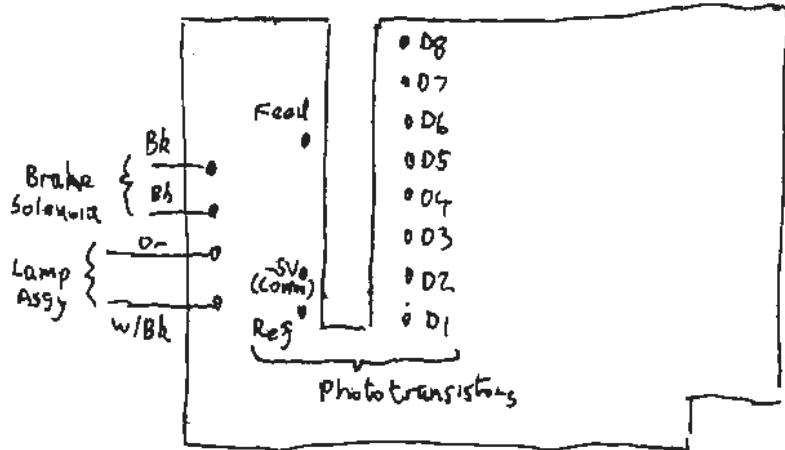
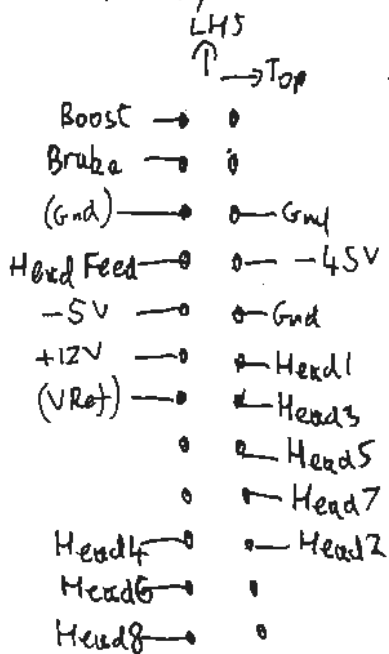

Read Head

Read Head PCB
(Bottom View)

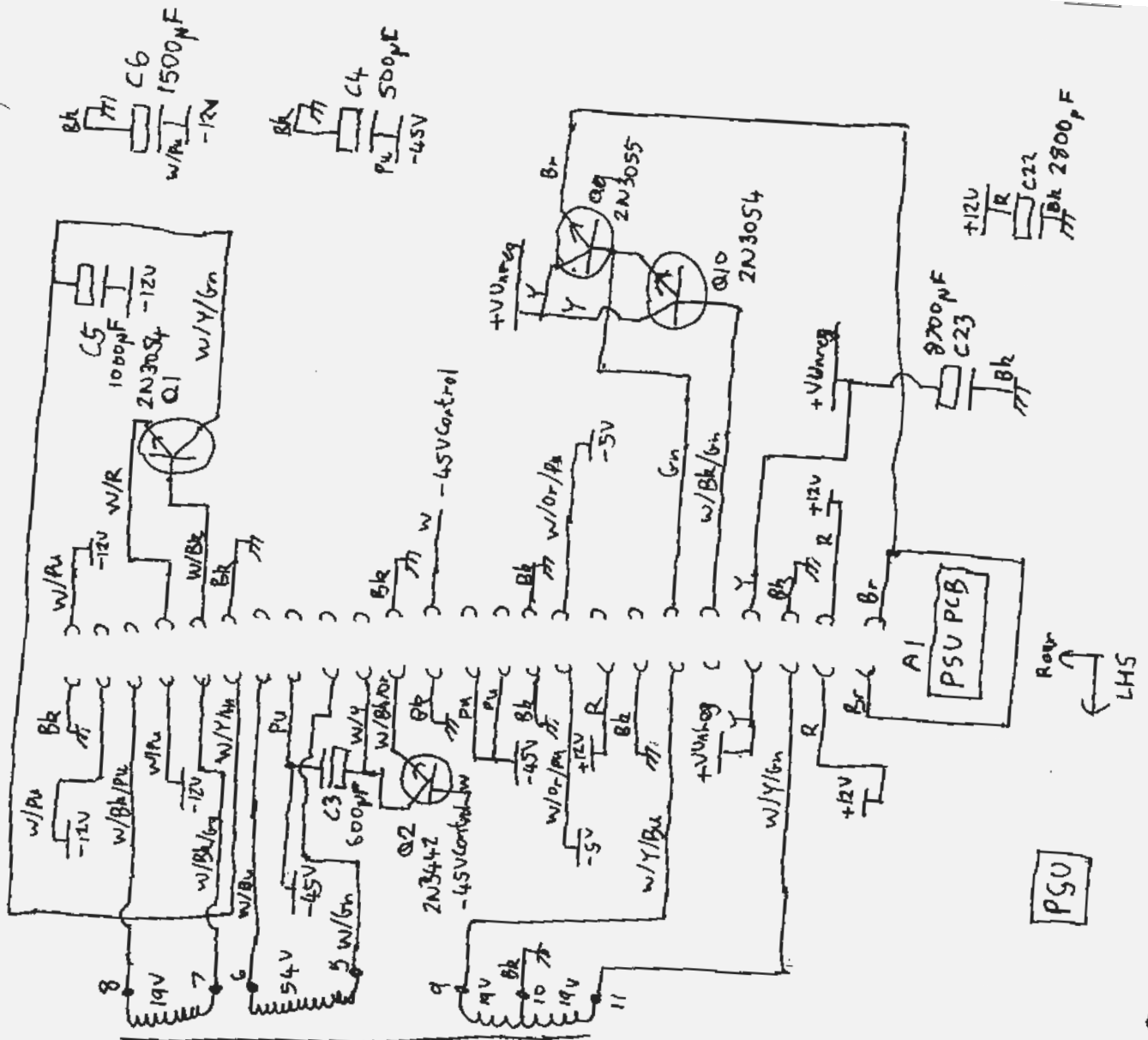
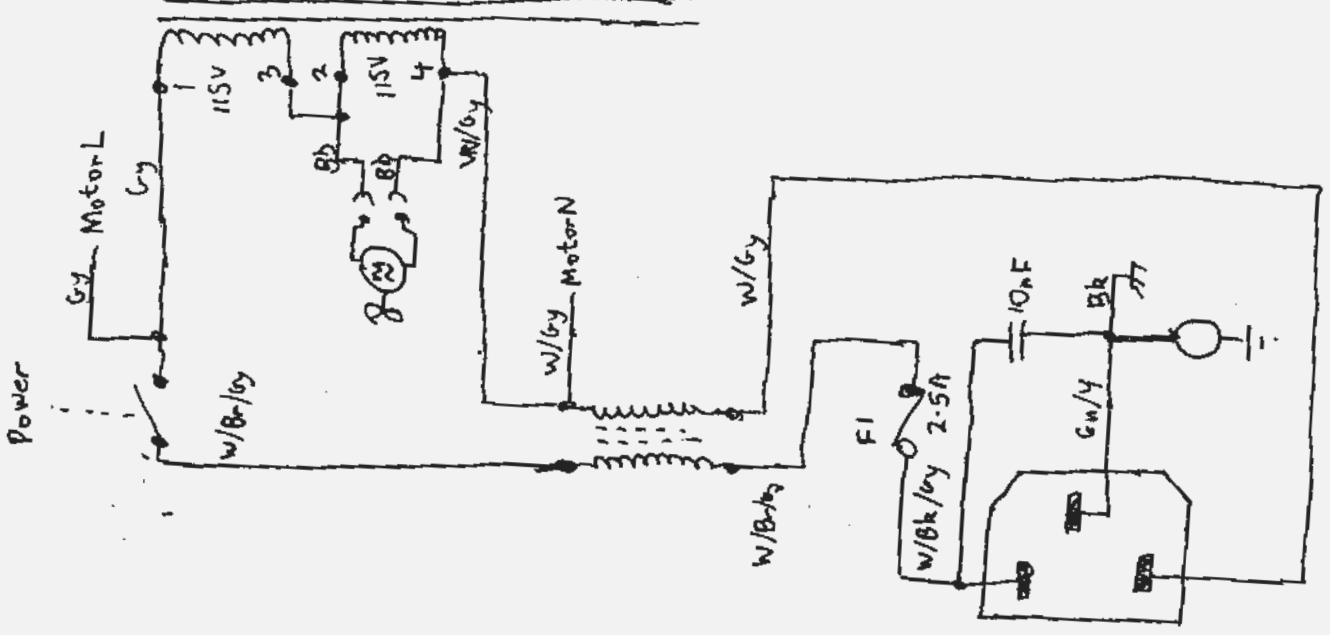

MD7768A Chassis Wiring Sheet ①

LHS

TB1

1

0

0

0

0

0

0

0

0

0

0

0

0

0

0

0

0

0

0

0

0

0

0

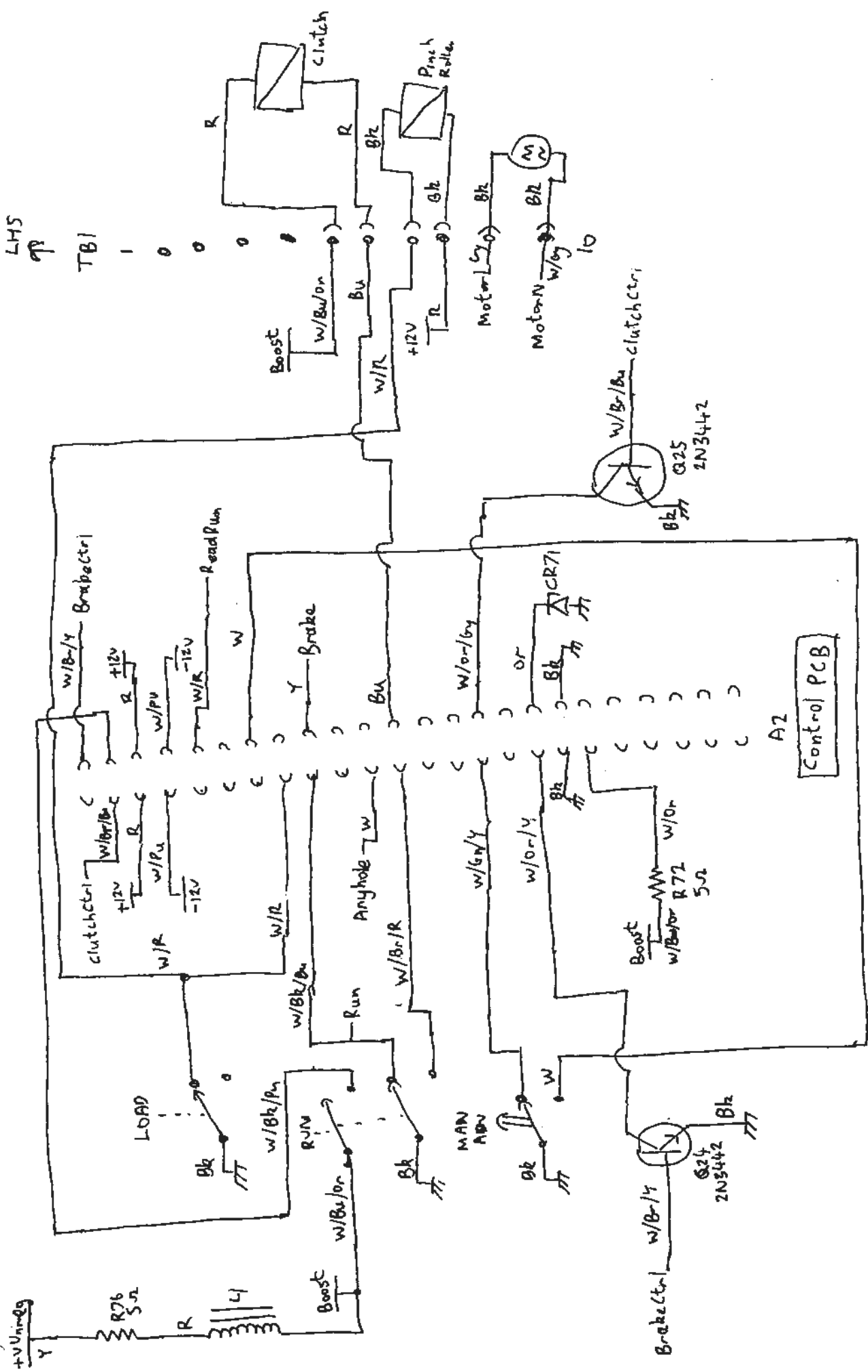

Rear
LHS

Classic Wiring Sheet

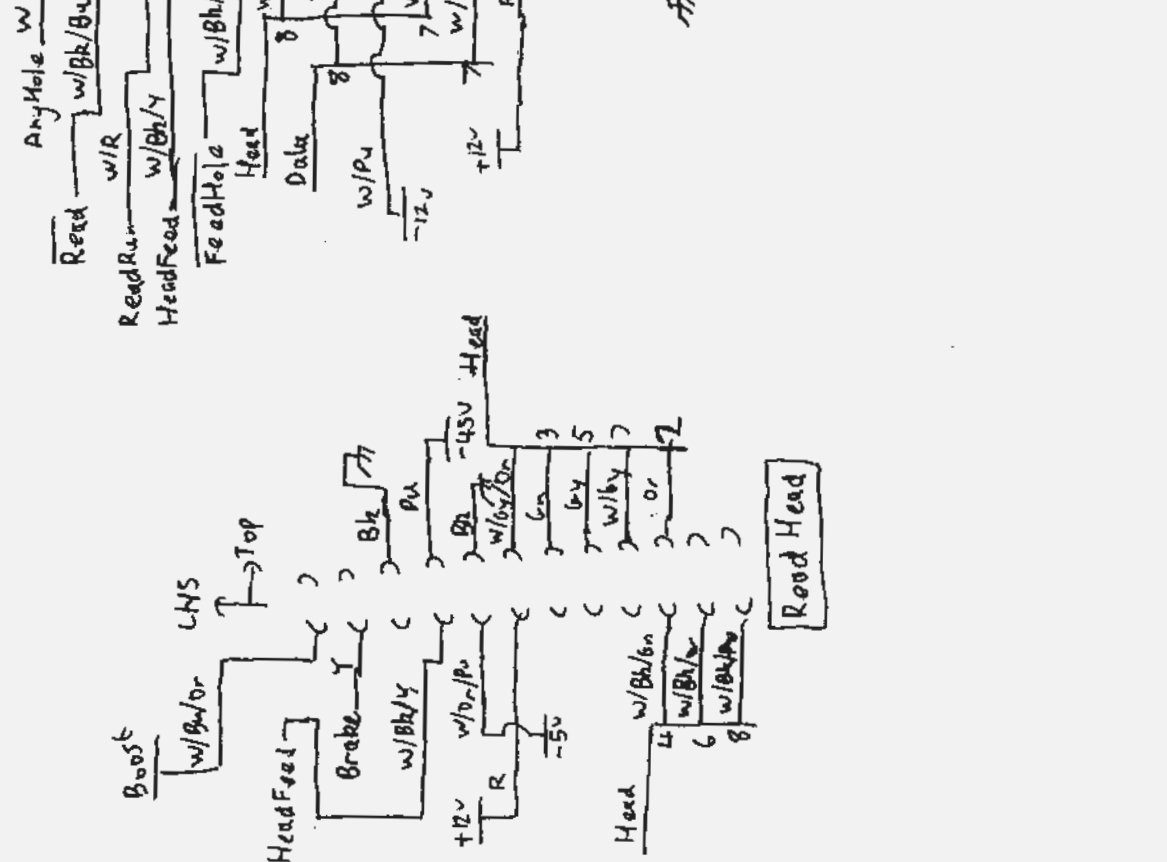
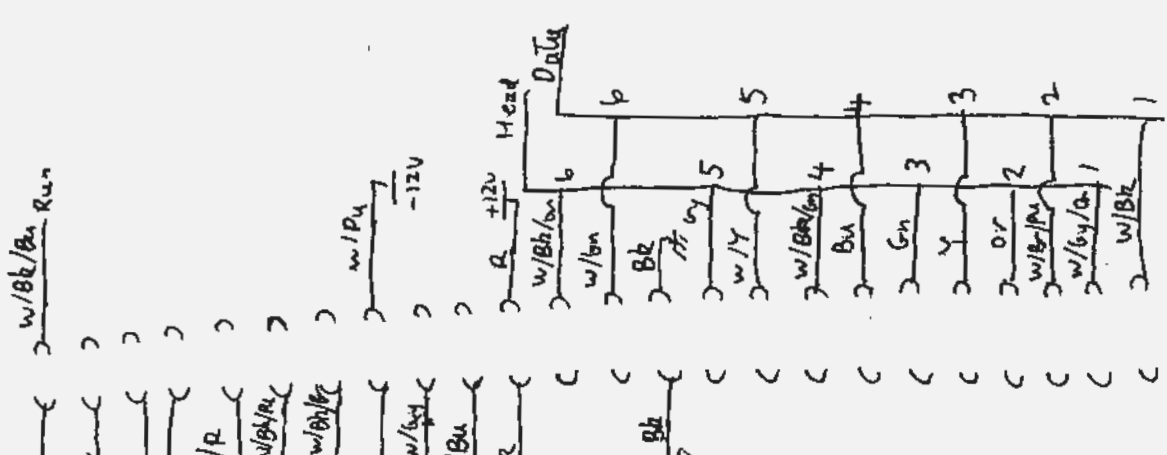
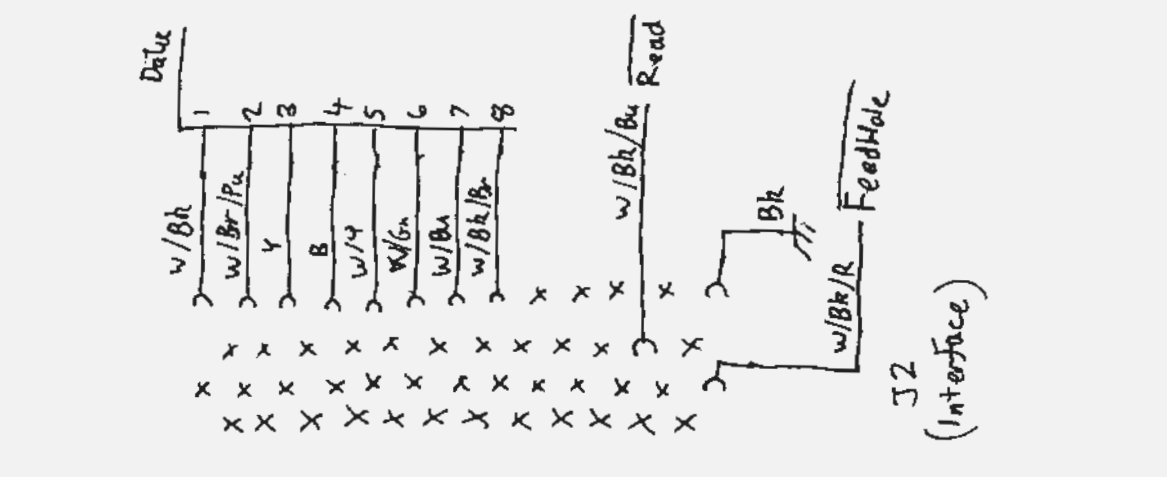

A3
Data PCB

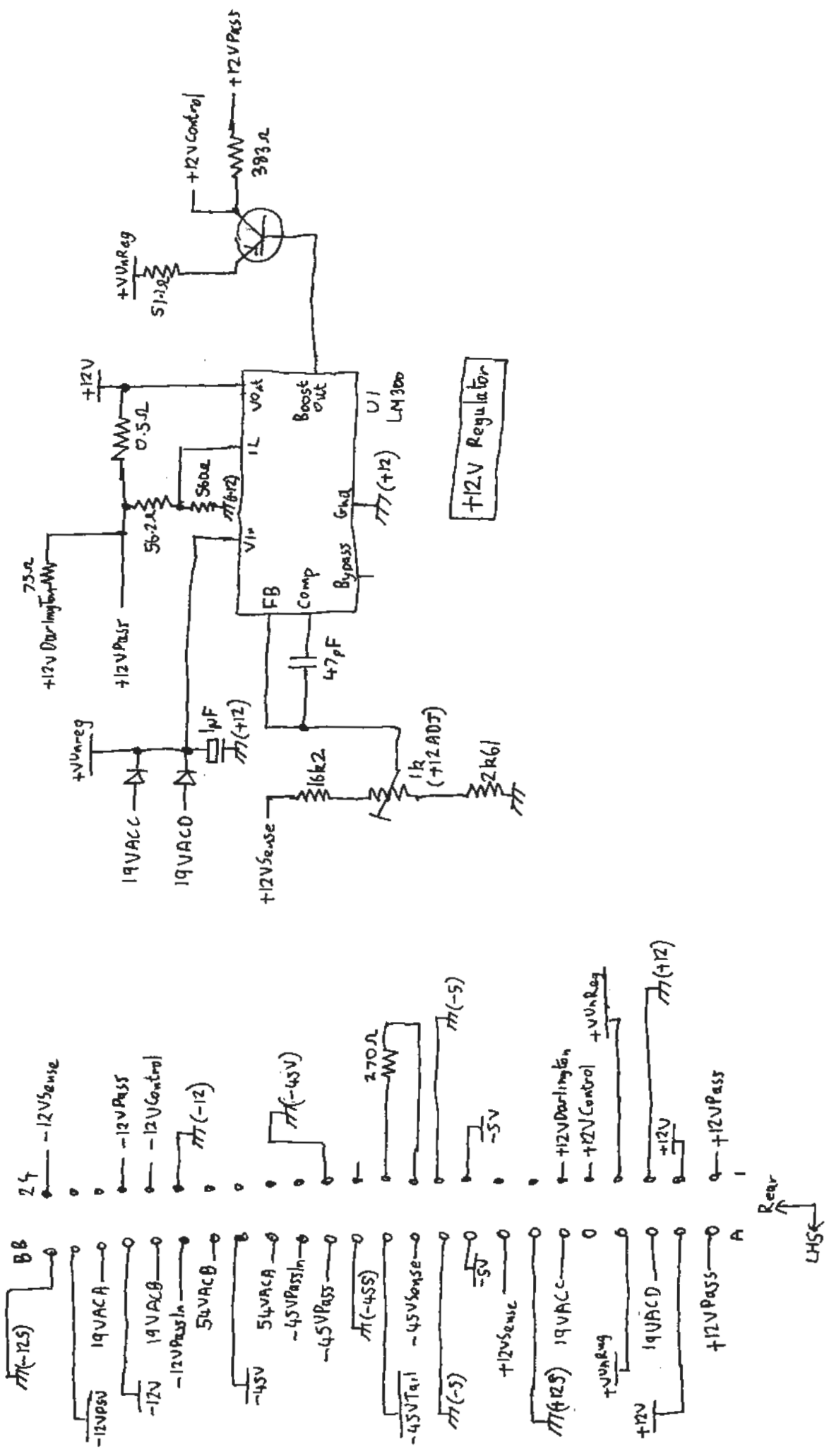

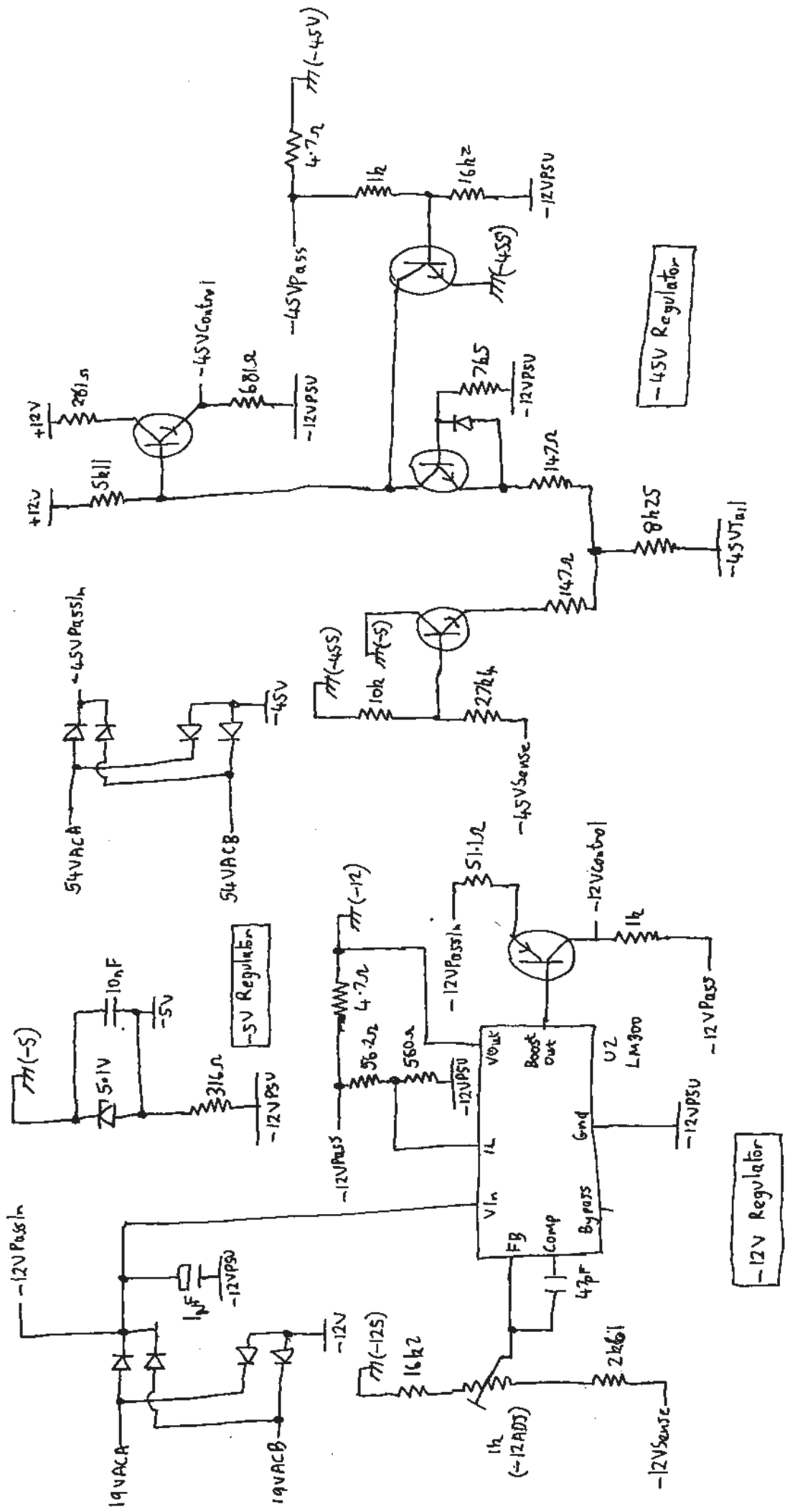

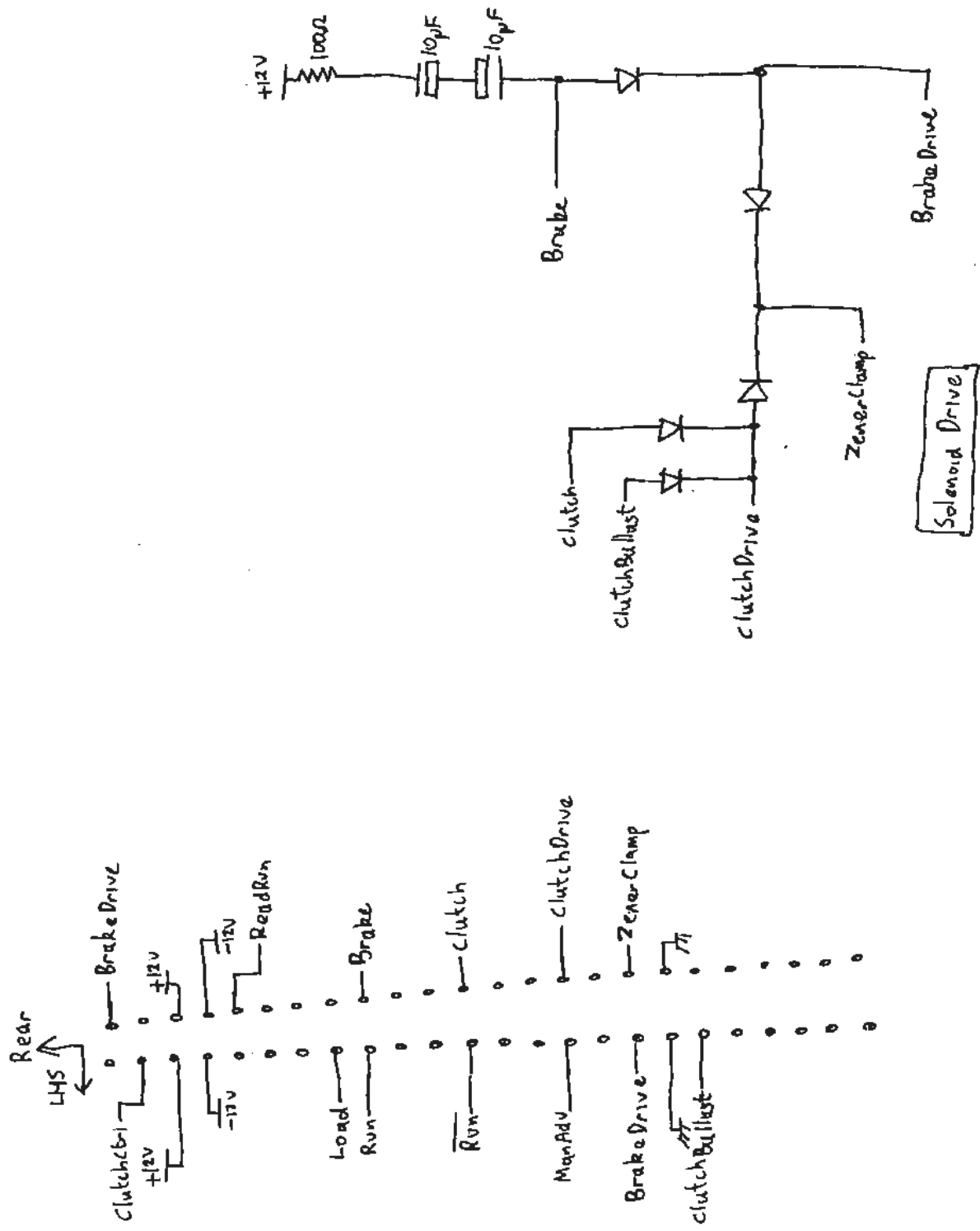

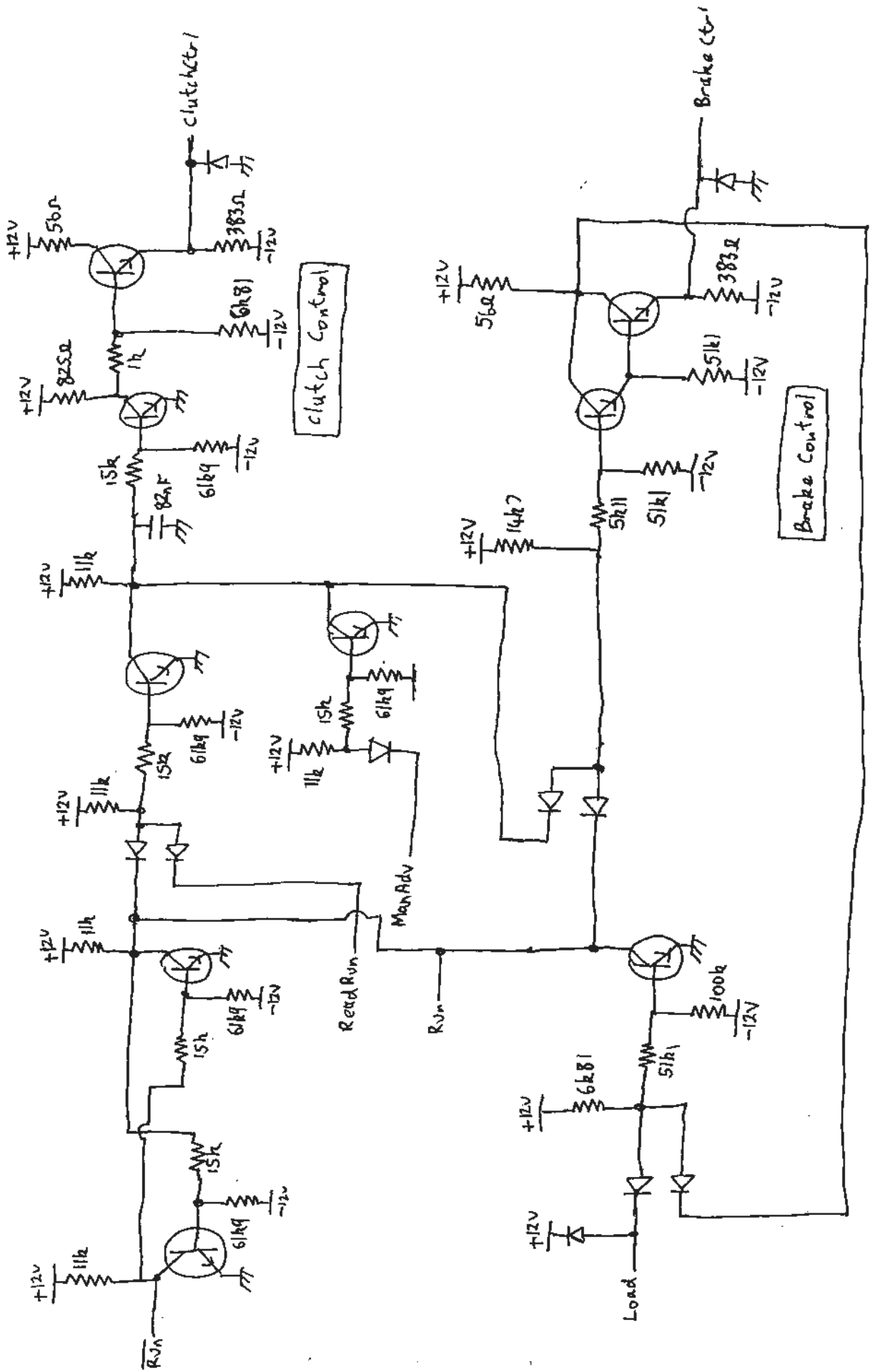

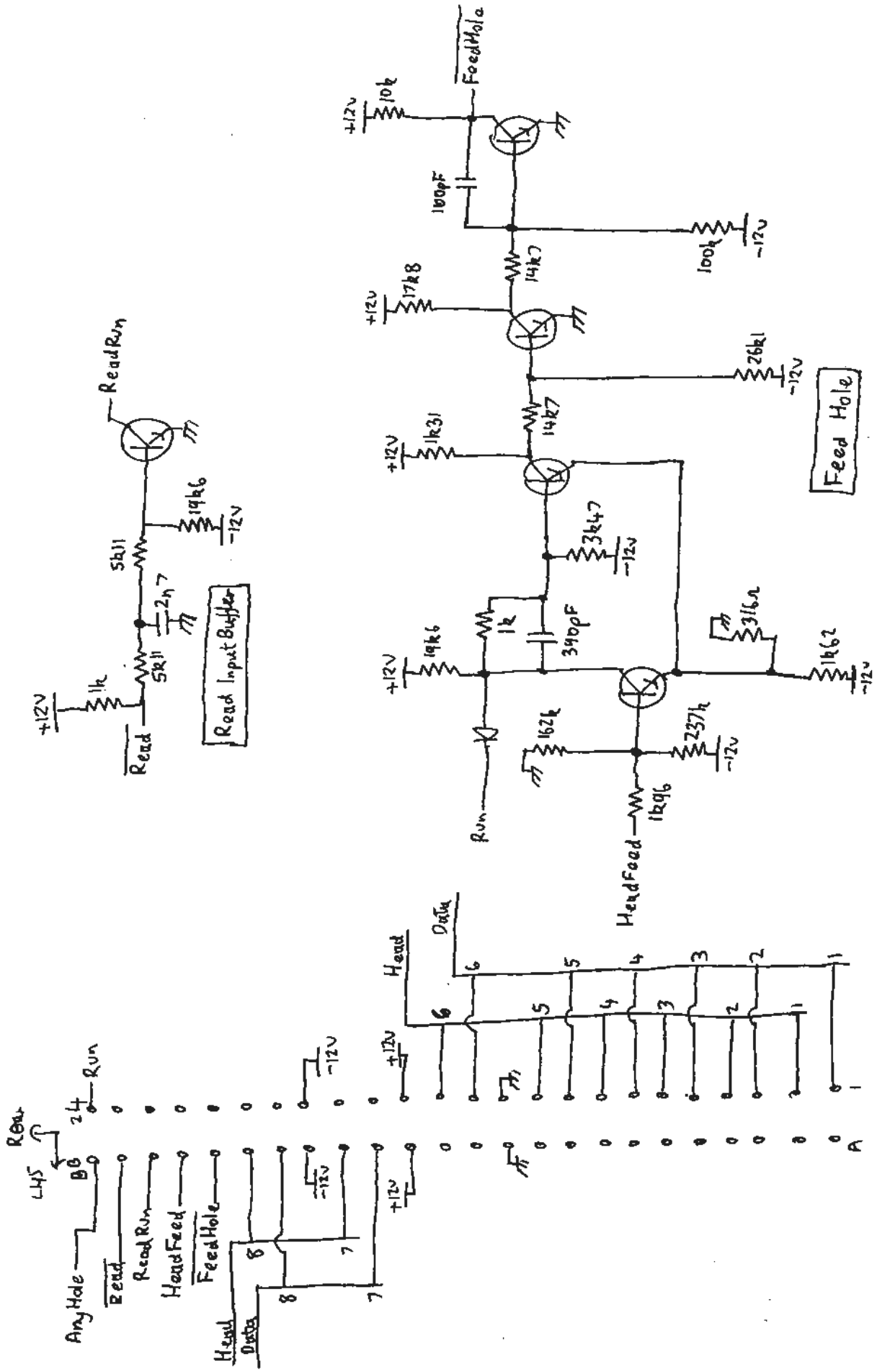

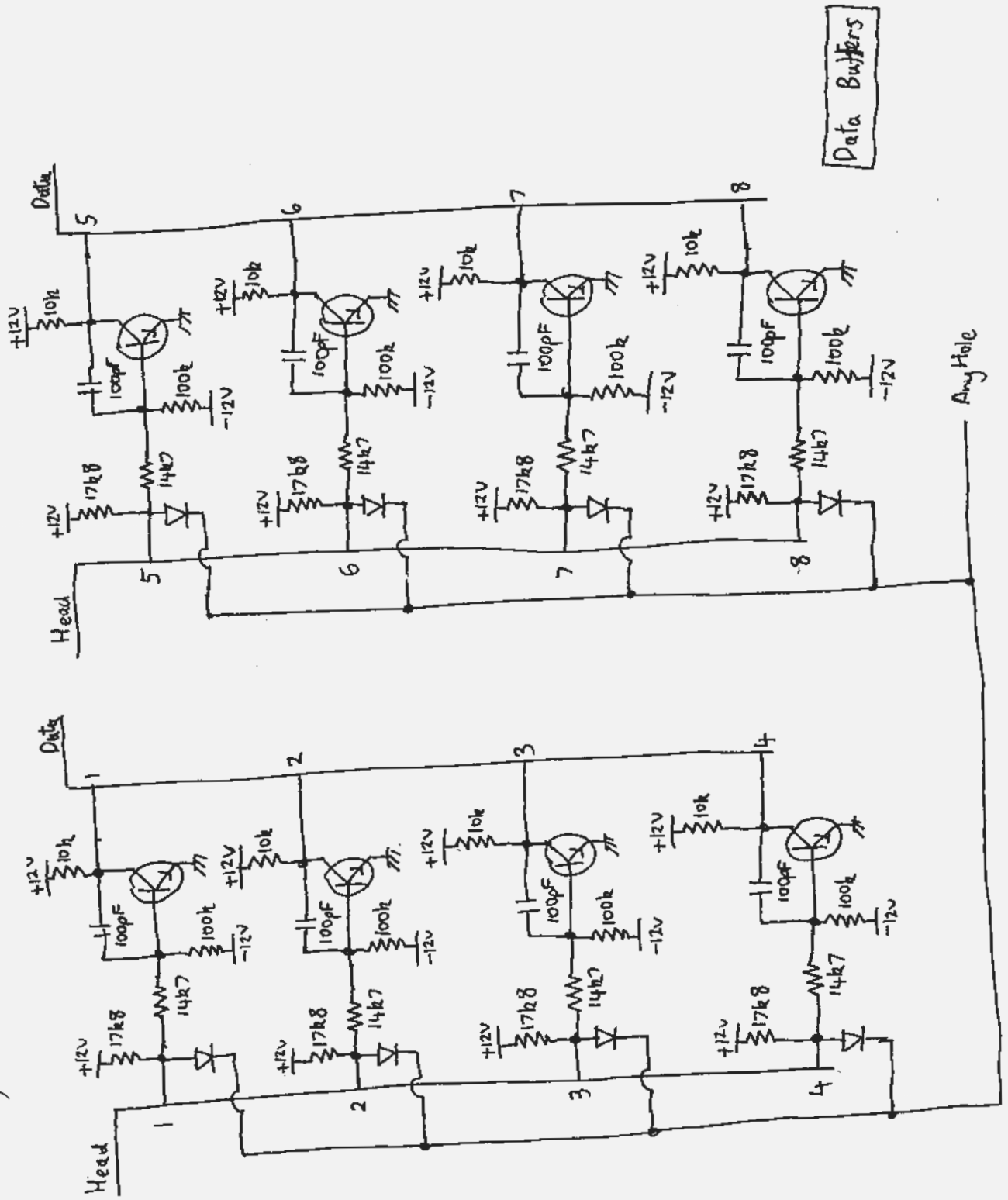

Any Hole

