

HP 35731

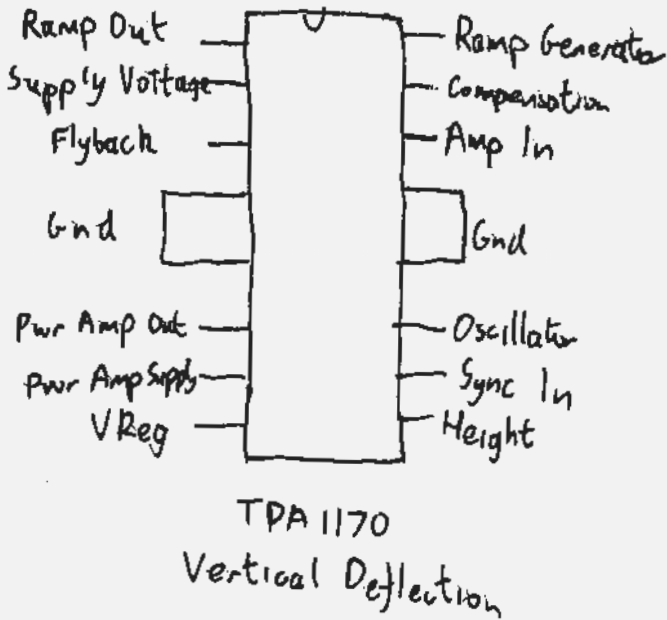

Component Numbers

- 1xx Video Input
- 2xx Video Output
- 3xx Vertical Deflection
- 4xx Horizontal Deflection
- 5xx HV
- 6xx PSU
- 7xx HP-MIL

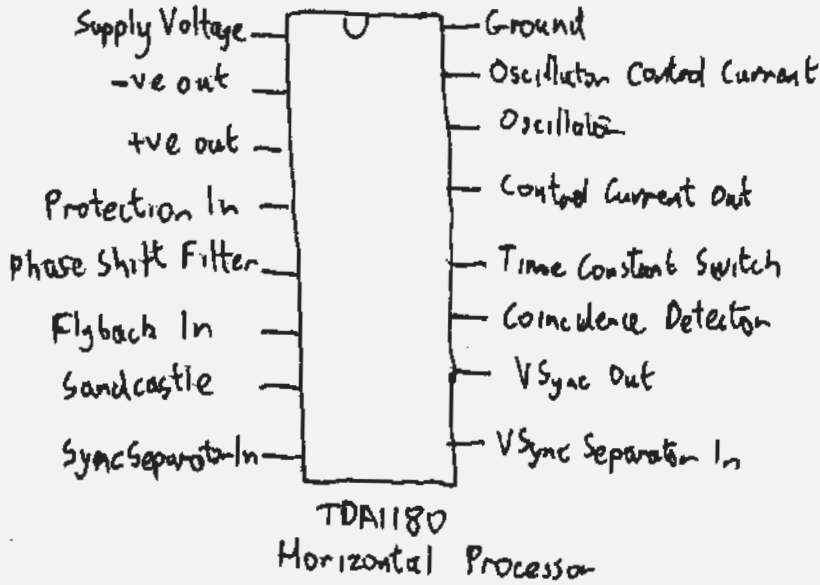
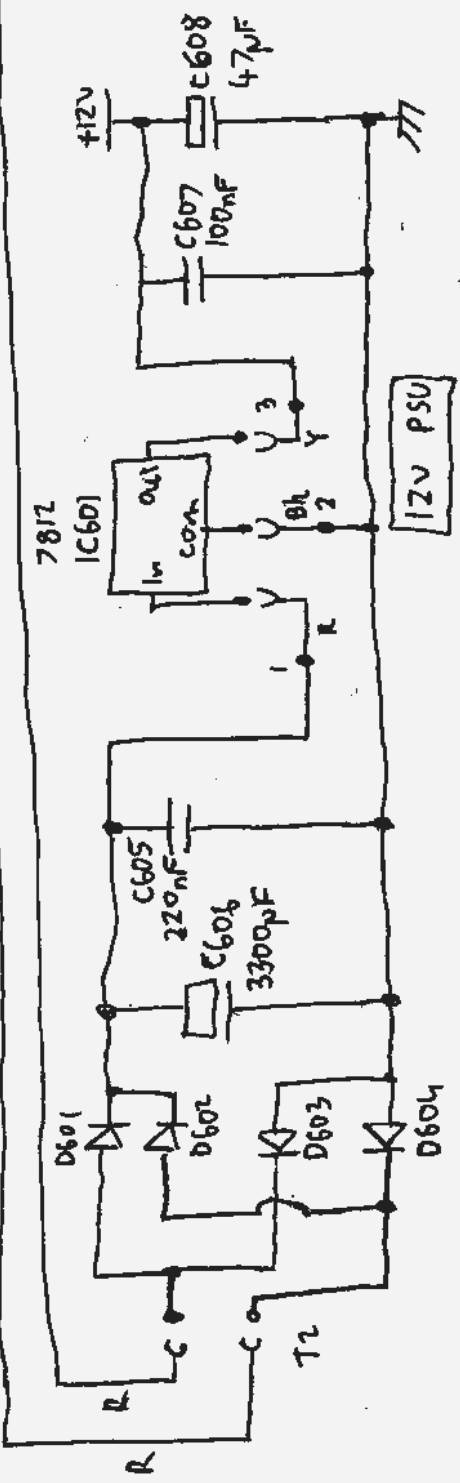
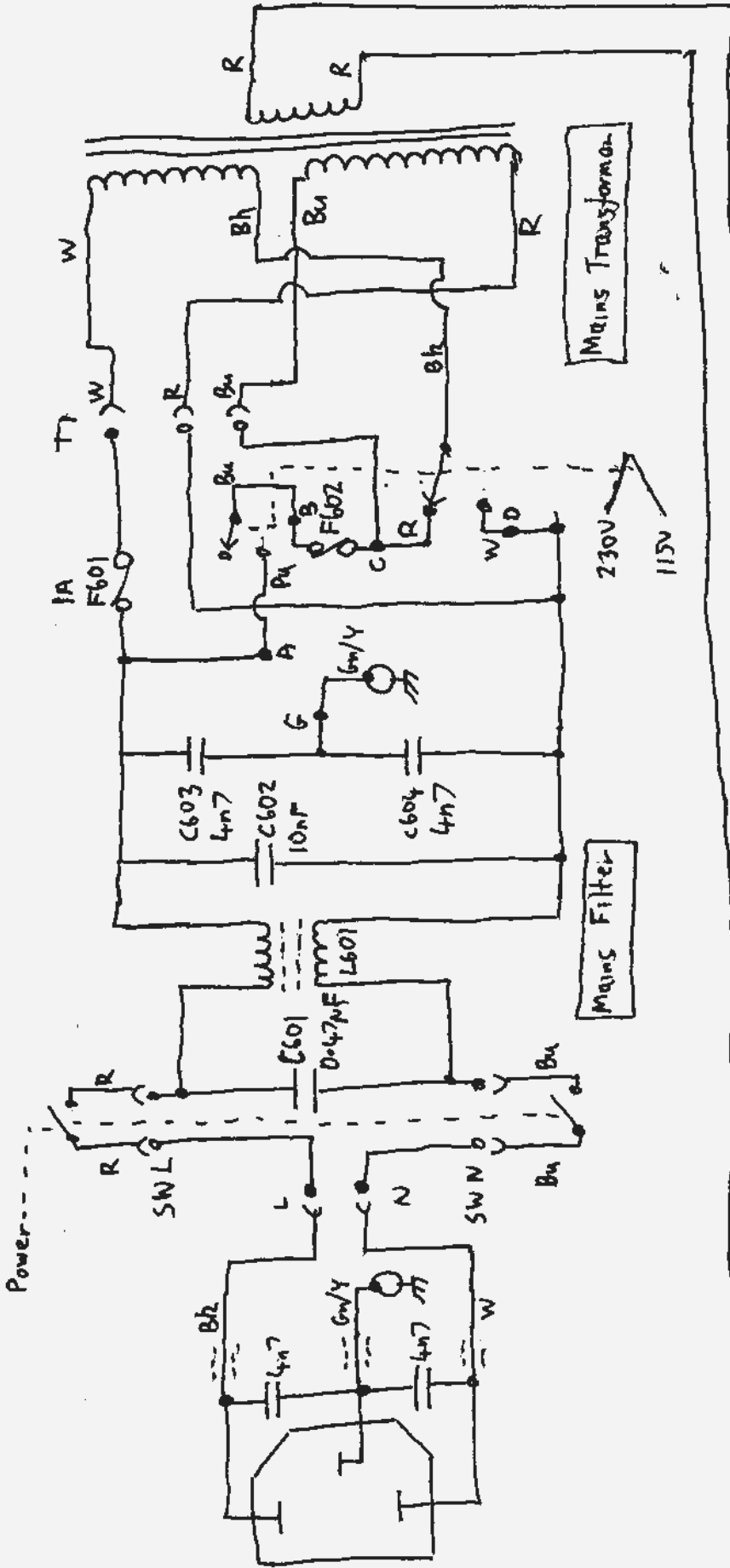

22-04-012

HP 35731 Monitor Sheet ①

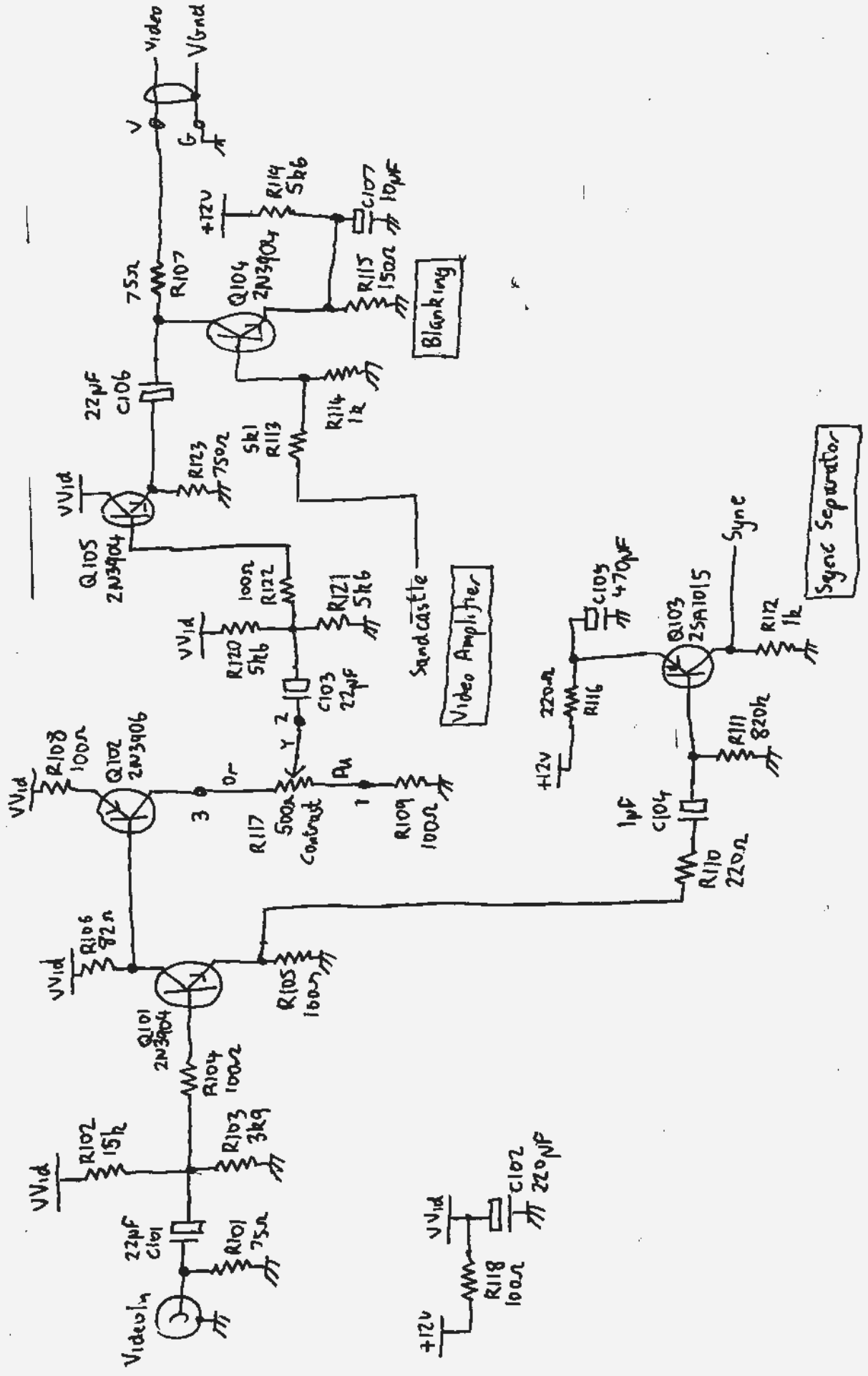

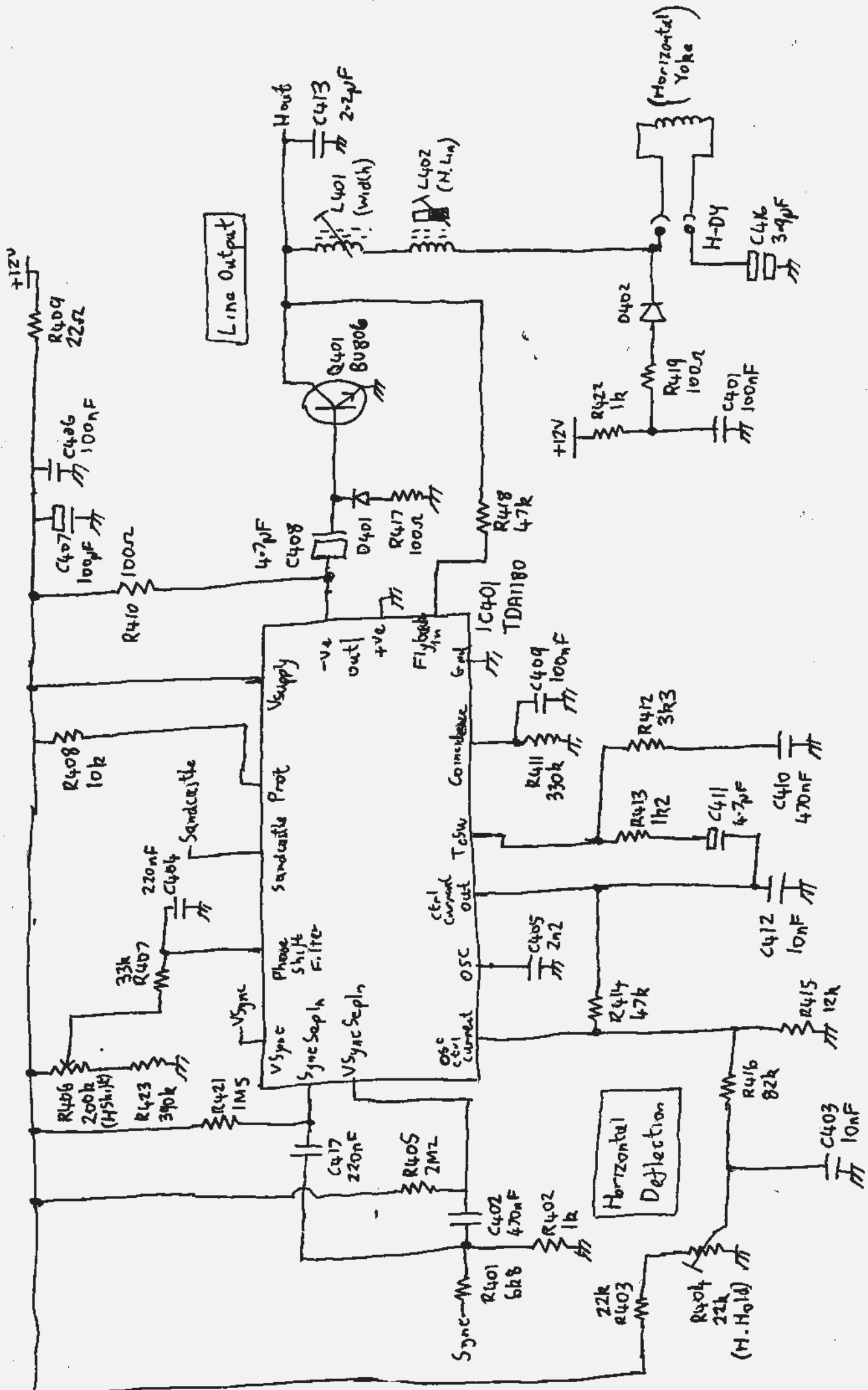

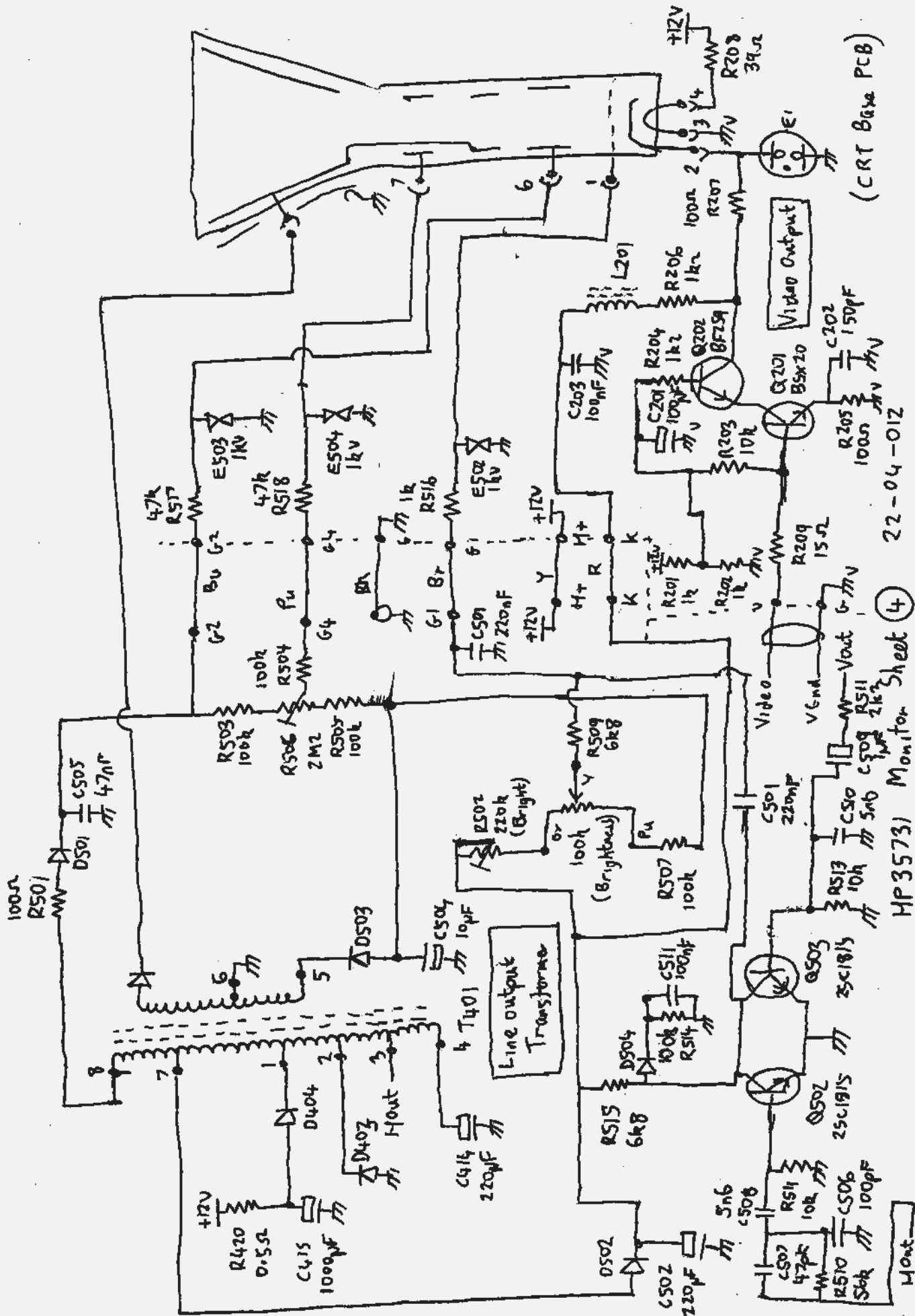

(CRT Base PCB)

22-04-01Z

HP 35731 Monitor Sheet 4

Mont

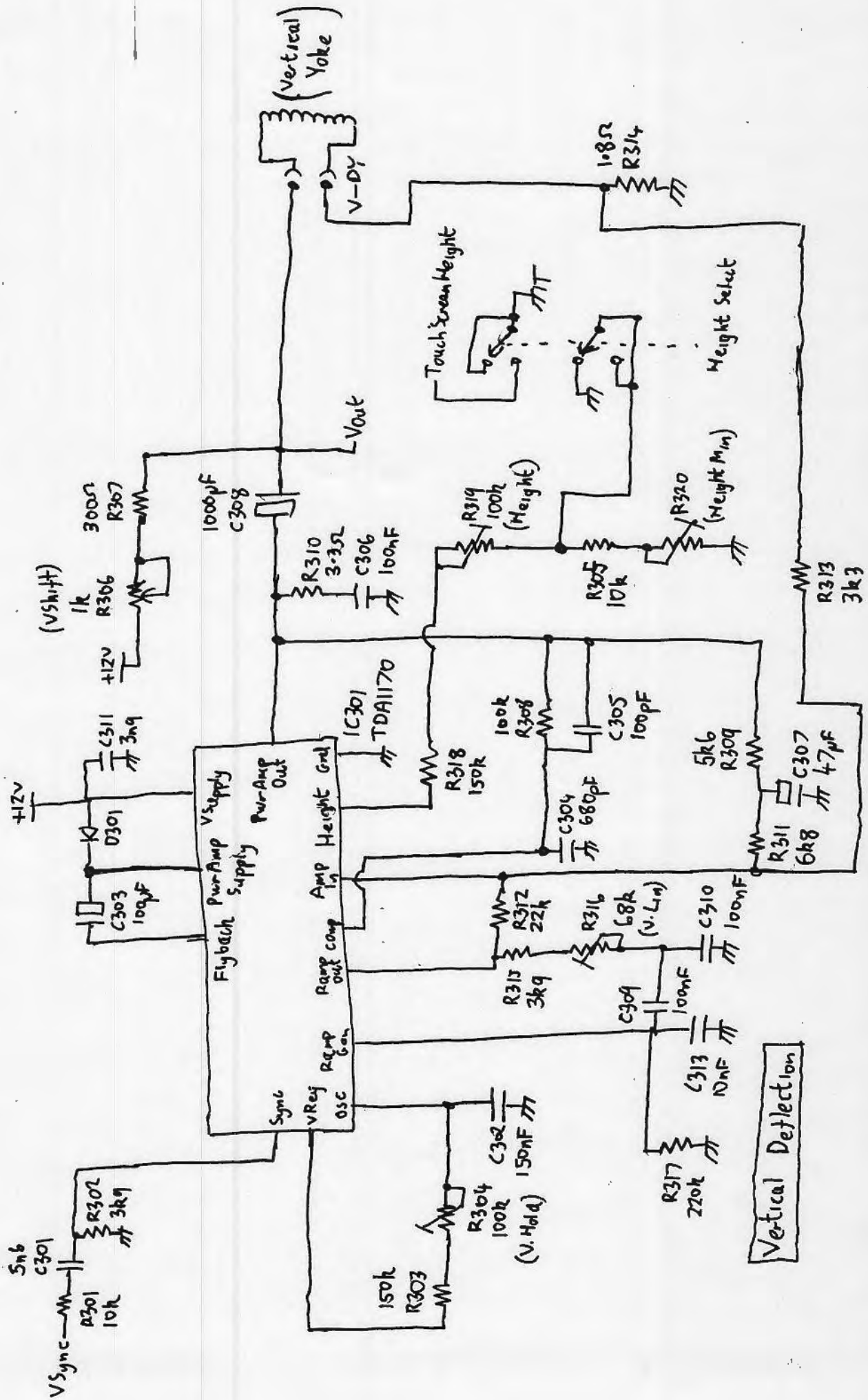

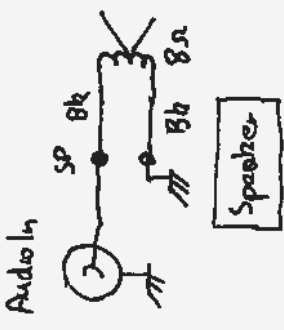
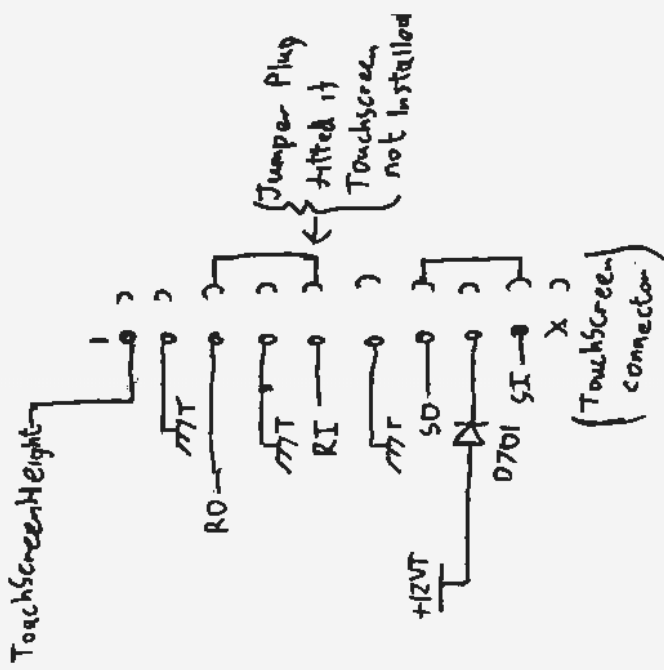
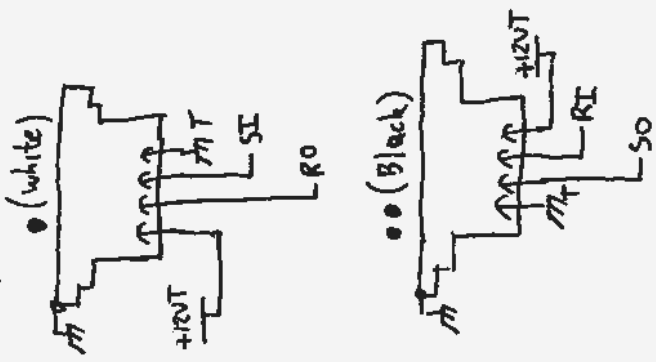

TouchScreen Connectors